

VERDÚ

ALK 

TIRADORES

HANDLES



El presente catálogo ha sido elaborado y es propiedad de Verdú.

Queda prohibida la impresión, reproducción, imitación de las ilustraciones o configuración parcial o total de este catálogo salvo autorización expresa de Verdú.

La empresa podría modificar el diseño y construcción del mismo.

La empresa queda excluida de toda responsabilidad de errores ajena a la misma como problemas en la traducción o en la impresión.

El presente catálogo ha sido elaborado por el equipo técnico y de diseño de Verdú.

VERDÚ
ALK ✓

The following catalogue is property and has been made by Verdu.

The catalogue's printing and/or imitation of its illustrations and partial or total configuration is prohibited unless it is explicitly authorised by Verdu.

The firm could modify its design and structure.

The firm does not take on responsibility for any third parties mistakes as well as errors in its translation or printing.

The following catalogue has been made by Verdú's technical and design team.

LAS VENTAJAS DE USAR NUESTRA WEB

Benefits of using our website



FACILIDADES

Si accedes con tu cuenta profesional a la web, dispondrás de tus descuentos y condiciones de pago pactadas.



FACILITY

If you access the website with your professional account, you will have access to your discounts and agreed payment terms.



NOVEDADES

Te enviaremos por e-mail un boletín personalizado para que estés al tanto de nuestras novedades.



NEWS

We will send you a personalized newsletter by e-mail to keep you up to date with our latest news.



FACTURAS

Podrás consultar y descargar todas tus facturas desde el historial, incluso si realizaste el pedido por otras vías.



INVOICES

You will be able to view and download all your invoices from your invoice history, even if the order was placed by other means.



AHORRA

Ahorrarás tiempo comprando online y conseguirás un 1% de descuento extra en todos los pedidos.



SAVE

You will save time shopping online and receive an additional 1% discount on all orders.



ESPECIFICACIONES

En las fichas de producto encontrarás detalles técnicos: medidas, materiales e incluso instrucciones de montaje.



SPECIFICATIONS

In the product sheets you will find technical details: measurements, materials... and even assembly instructions.



PEDIDO RÁPIDO

Si compras productos habituales, este sistema nuevo te ahorrará aún más tiempo.



QUICK ORDER

If you regularly purchase the same products, this new system will save you even more time.



COMO USAR LOS CÓDIGOS QR

HOW TO USE QR CODES

Utiliza los códigos QR que encontrarás en el catálogo para disfrutar de una mejor experiencia de uso. Te explicamos cómo funciona. Si tienes un teléfono móvil Android o iOS, podrás escanear estos códigos con la cámara de tu dispositivo y acceder a vídeos, dibujos e instrucciones de montaje.

Si tu dispositivo no puede leerlos, puedes descargar gratuitamente una aplicación lectora de códigos QR desde App Store o Play Store.

Use the QR codes included in the catalogue for a better user experience. We explain how they work.

If you have an Android or iOS smartphone, you can scan these codes using your device's camera to access videos, drawings and assembly instructions.

If your device cannot read them, you can download a free QR scanner app from the App Store or Google Play.

¡ES MUY SENCILLO!
IT'S VERY EASY!!

AHORA MÁS FÁCIL CON VERDÚ

Now easier with Verdú

SI TODAVÍA NO TRABAJAS CON NOSOTROS...

ES

Regístrate como profesional y accede con tu cuenta a la web; dispondrás de descuentos y ventajas profesionales. Si todavía no formas parte de esta gran comunidad, entra en www.verdustore.com y verás el enlace en el menú superior. Rellena los datos y recibirás la contraseña en tu e-mail.

¡¡OJO!! Revisa la carpeta SPAM de tu e-mail si no ves el correo en tu bandeja de entrada.

IF YOU DON'T WORK WITH US YET...

EN

Register as a professional user and access your online account to enjoy discounts and professional benefits.

If you are not yet part of our community, visit www.verdustore.com and click the link in the top menu. Fill in the required information and you will receive your password by e-mail.

WARNING! Check your SPAM folder if you cannot find the e-mail in your inbox.



Regístrate como profesional
Register as a professional

SI TIENES FICHA, PERO NO TRABAJAS ONLINE...

ES

Si ya tienes ficha abierta en Verdú, es decir, que ya estás registrado como profesional, y todavía no tienes las claves, puedes solicitarlas para comprar por la web. ¡Es fácil y rápido!

Entra en www.verdustore.com y verás el enlace en el menú superior. Con solo rellenar unos sencillos datos, recibirás la contraseña en tu e-mail.

¡¡OJO!! Revisa la carpeta SPAM de tu e-mail si no ves el correo en tu bandeja de entrada.

IF YOU HAVE A FILE, BUT YOU DON'T WORK ONLINE...

EN

If you already have an account with Verdú, meaning you are already registered as a professional customer, but do not yet have access credentials, you can request them to place orders online quickly and easily.

Visit www.verdustore.com and click the link in the top menu. Simply fill in a few details and you will receive your password by e-mail.

WARNING! Check your SPAM folder if you cannot find the e-mail in your inbox.



¡RÁPIDO Y AL MOMENTO!
FAST AND IMMEDIATE!







Desde 1893, cuatro generaciones han trabajado con el mismo compromiso: hacer crecer un legado basado en el esfuerzo, la constancia y la responsabilidad

Since 1893, four generations have shared the same commitment: to build a legacy based on effort, perseverance, and responsibility.

Creceamos juntos

En Verdú, la tradición y la innovación, se entrelazan para ofrecer soluciones excepcionales en herrajes y suministros industriales para el mueble. Con raíces profundas en Yecla, Murcia, nuestra compañía ha sido sinónimo de calidad y vanguardia desde el año 1893.

Hemos consolidado un legado apoyándonos en nuestras amplias instalaciones que abarcan más de **10.000m²**, con espacios comerciales de más de 3.000 m² y 8.000 m² de almacén, que cubren las necesidades de los clientes más exigentes.

En Joaquín Verdú Díaz SLU, cada día nos dedicamos a la innovación, con ella crecemos y afrontamos los retos del futuro con confianza. Estamos constantemente en la búsqueda de métodos y materiales que nos permitan estar a la vanguardia del diseño y la funcionalidad, ofreciendo soluciones que definen tendencias en el mundo del mueble.

Este catálogo es más que una simple colección de productos; es una ventana a nuestra alma como compañía. Aquí encontrarás no solo herrajes y suministros de la más alta calidad, sino también el reflejo de nuestro compromiso con la innovación, la calidad y el servicio excepcional.

Growing together

At Verdú, tradition and innovation are intertwined to offer exceptional solutions in hardware and industrial supplies for furniture. With deep roots in Yecla, Murcia, our company has been synonymous with quality and avant-garde since 1893.

We have consolidated a legacy based on our extensive facilities, which cover more than 10,000 m², with commercial spaces of more than 3,000 m² and 8,000 m² of warehouse space, meeting the needs of the most demanding customers.

At Joaquín Verdú Díaz SLU, every day we dedicate ourselves to innovation; with it, we grow and face the challenges of the future with confidence. We are constantly searching for methods and materials that allow us to be at the forefront of design and functionality, offering solutions that define trends in the furniture industry.

This catalogue is more than just a collection of products; it is a window into our soul as a company. Here you will find not only the highest-quality hardware and supplies, but also a reflection of our commitment to innovation, quality, and exceptional service.

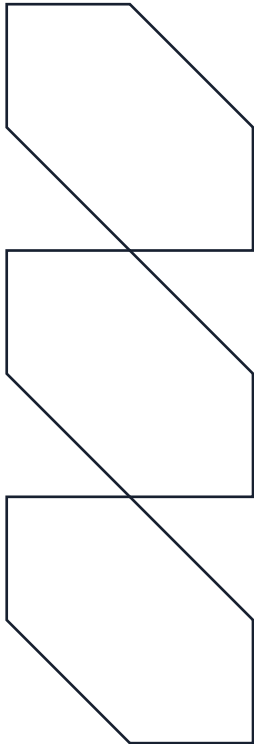

Evolucionar forma parte de quienes somos. Incorporamos soluciones inteligentes para avanzar con solidez, año tras año.
Evolution is part of who we are. We integrate intelligent solutions to move forward with strength and consistency year after year.





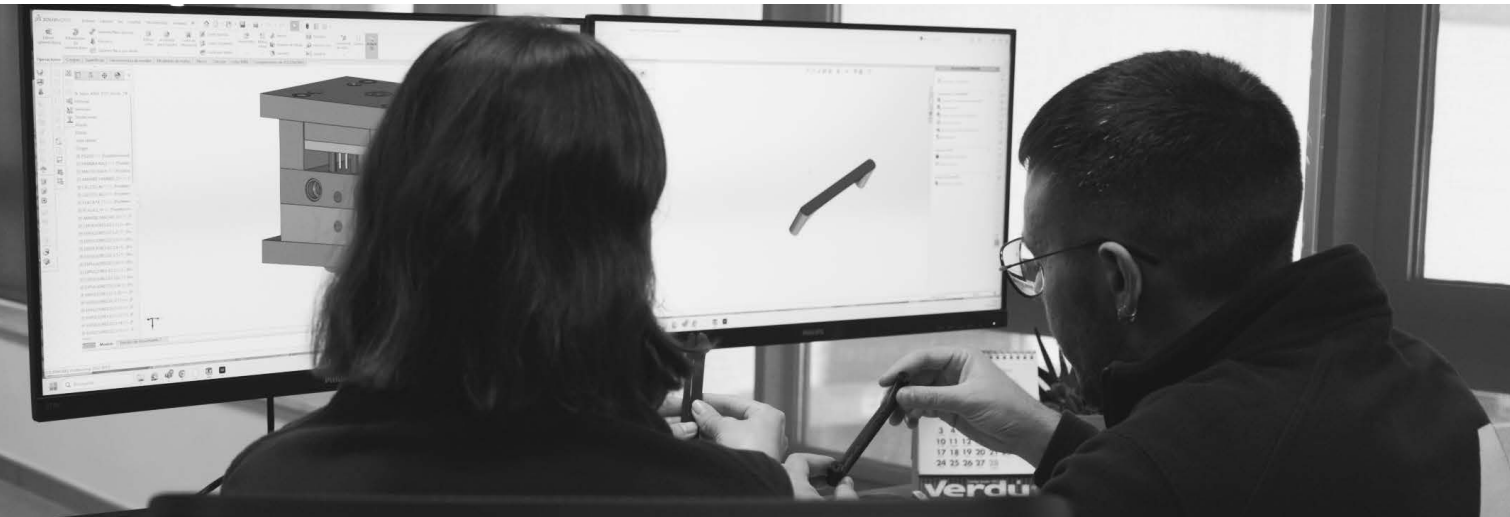

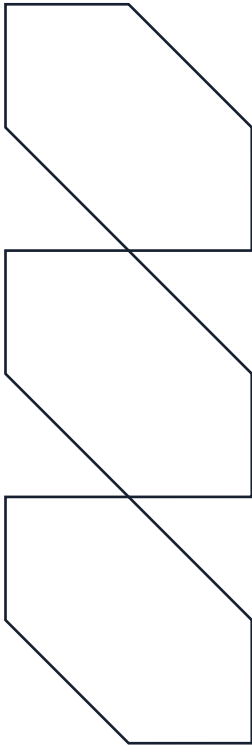

Nuestro compromiso con la fabricación y el diseño garantiza innovación, resistencia y atención al detalle en cada etapa.

Our commitment to manufacturing and design ensures innovation, durability, and attention to detail at every stage of the process.

ÍNDICE
INDEX

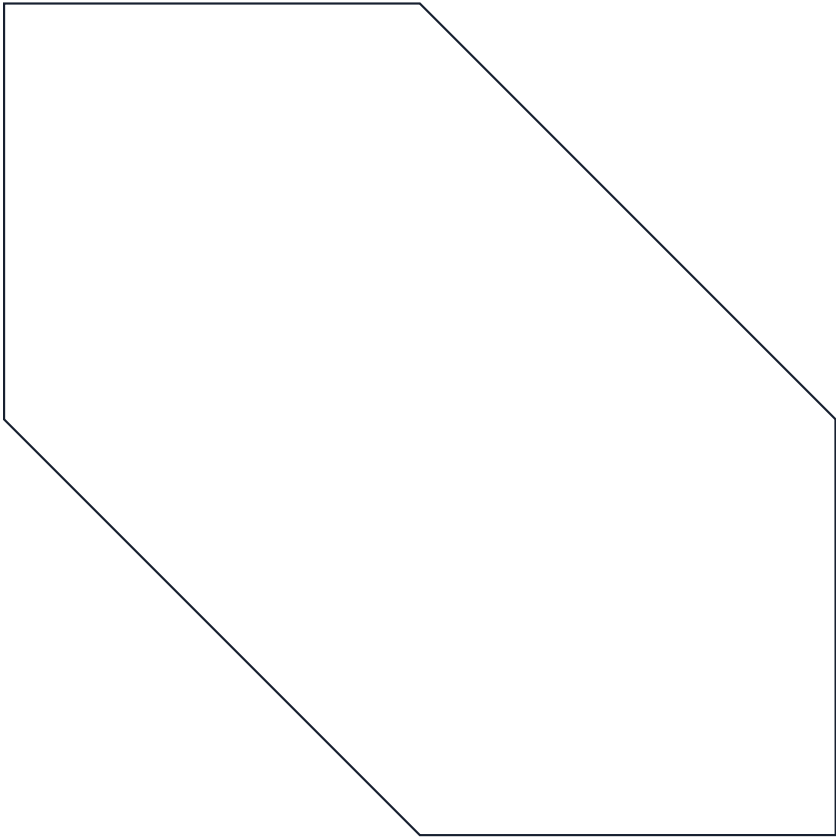
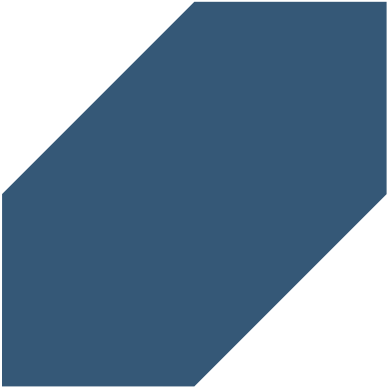

13 / NEW
NOVEDADES Zamak
Madera Wood
Aluminio Aluminium

101 / HANDLES AND KNOBS
TIRADORES Y POMOS Zamak
Madera Wood
Aluminio Aluminium
Pástico Plastic
Acero Inox Stainless steel

197 / PROFILE HANDLES
TIRADORES DE PERFIL Zamak
Aluminio Aluminium

221 / RECESSED HANDLES
TIRADORES DE EMBUTIR Zamak
Aluminio Aluminium
Acero Inox Stainless steel

237 / SCREWS
TORNILLOS

ONIKA

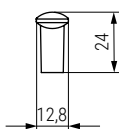
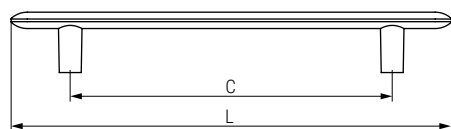

Código Code	C	L	Acabado Finish	
9042.136	96	144	mocca gold/mocha gold	1/50
9042.137	96	144	oro satinado/satin gold	1/50
9042.138	96	144	antracita/anthracite	1/50
9042.139	96	144	negro mate/matt black	1/50
9042.140	96	144	níquel cepillado/brushed nickel	1/50
9042.141	128	176	mocca gold/mocha gold	1/50
9042.142	128	176	oro satinado/satin gold	1/50
9042.143	128	176	antracita/anthracite	1/50
9042.144	128	176	negro mate/matt black	1/50
9042.145	128	176	níquel cepillado/brushed nickel	1/50
9042.146	192	240	mocca gold/mocha gold	1/25
9042.147	192	240	oro satinado/satin gold	1/25
9042.148	192	240	antracita/anthracite	1/25
9042.149	192	240	negro mate/matt black	1/25
9042.150	192	240	níquel cepillado/brushed nickel	1/25

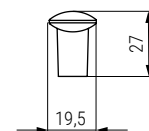
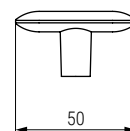

Código Code	Acabado Finish	
9042.131	mocca gold/mocha gold	1/50
9042.132	oro satinado/satin gold	1/50
9042.133	antracita/anthracite	1/50
9042.134	negro mate/matt black	1/50
9042.135	níquel cepillado/brushed nickel	1/50





BRUTUS

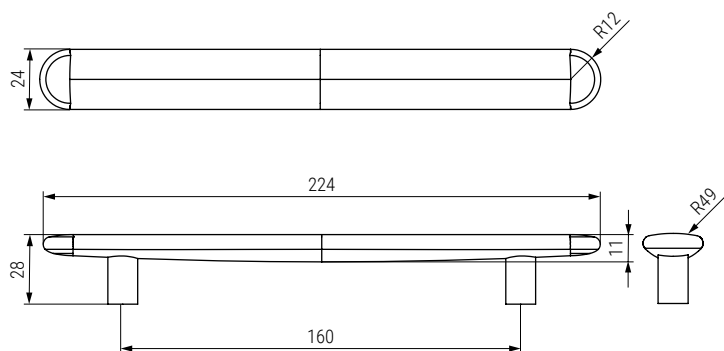

Código Code	Acabado Finish	
553.187	roble/oak	1/50
553.188	nogal/walnut	1/50



VALLE

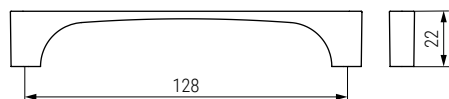
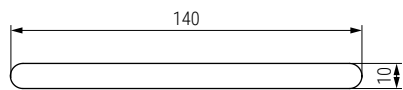

Código Code	Acabado Finish	
9035.521	gris RAL 9006/grey RAL 9006	1/50
9035.522	negro mate/matt black	1/50
9035.523	blanco mate/matt white	1/50
9035.524	latón satinado/satin brass	1/50

PINTA



Código Code	Acabado Finish	
553.183	roble/oak	1/50
553.184	nogal/walnut	1/50

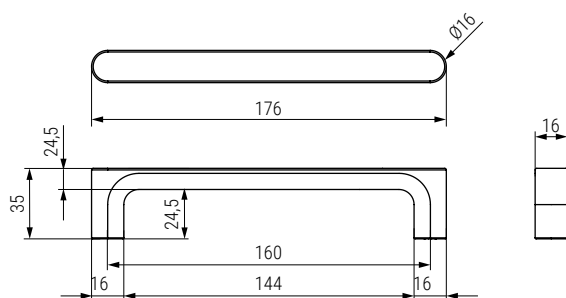





KESIA

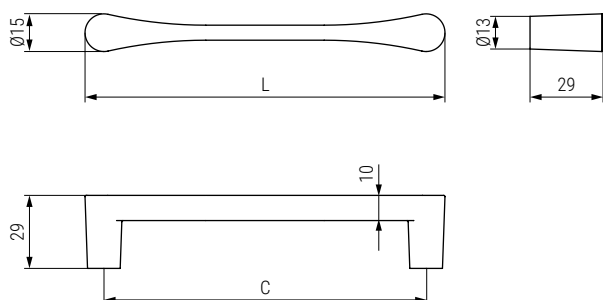

Código Code	C	L	Acabado Finish	
9042.173	96	112	niquel cepillado/brushed nickel	1/50
9042.174	96	112	negro mate/matt black	1/50
9042.175	96	112	mocca gold/mocha gold	1/50
9042.176	128	144	niquel cepillado/brushed nickel	1/50
9042.177	128	144	negro mate/matt black	1/50
9042.178	128	144	mocca gold/mocha gold	1/50
9042.179	192	208	niquel cepillado/brushed nickel	1/25
9042.180	192	208	negro mate/matt black	1/25
9042.181	192	208	mocca gold/mocha gold	1/25

KOVA



Código Code	C	L	Acabado Finish	
9042.151	96	107	niquel cepillado/brushed nickel	1/50
9042.152	96	107	negro mate/matt black	1/50
9042.153	128	139	niquel cepillado/brushed nickel	1/50
9042.154	128	139	negro mate/matt black	1/50
9042.155	160	170	niquel cepillado/brushed nickel	1/40
9042.156	160	170	negro mate/matt black	1/40

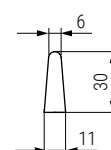
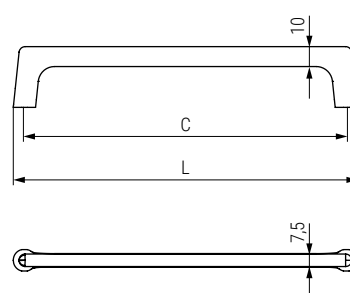



KUMO



Código Code	C	L	Acabado Finish	
991.1221	128	248	negro titanio/titanium black	1/25
991.1223	128	248	bronce cepillado/brushed bronze	1/25
991.1222	320	480	negro titanio/titanium black	1/25
991.1224	320	480	bronce cepillado/brushed bronze	1/25

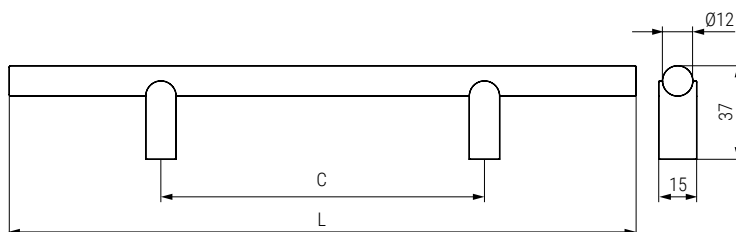



KUMO WOOD

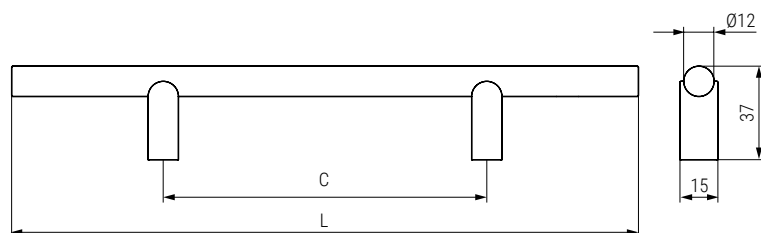

Código Code	C	L	Acabado Finish	
991.1171	128	248	roble-negro titanio/oak-titanium black	1/25
991.1173	128	248	nogal-negro titanio/walnut-titanium black	1/25
991.1172	320	480	roble-negro titanio/oak-titanium black	1/25
991.1174	320	480	nogal-negro titanio/walnut-titanium black	1/25



HINOKI

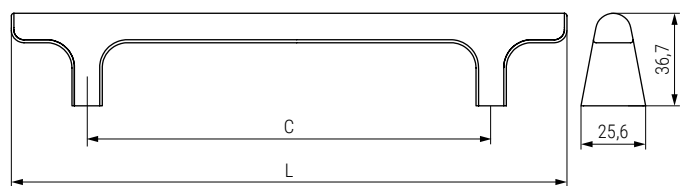

Código Code	C	L	Acabado Finish	
991.1128	160	220	negro cepillado/brushed black	1/25
991.1129	160	220	latón cava cepillado/brushed champagne brass	1/25
991.1130	160	220	bronce cepillado/brushed bronze	1/25





Código Code	Acabado Finish	
991.1125	negro cepillado/brushed black	1/25
991.1126	latón cava cepillado/brushed bronze	1/25
991.1127	bronce cepillado/brushed bronze	1/25



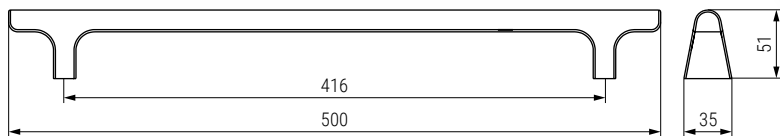

HINOKI BIG



Código Code	Acabado Finish	
991.1131	negro cepillado/brushed black	1/10
991.1132	latón cava/champagne brass	1/10
991.1133	bronce cepillado/brushed bronze	1/10

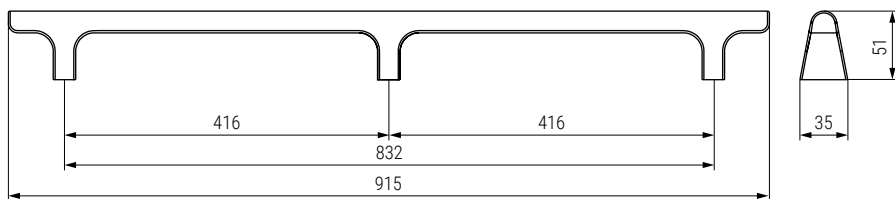

Código Code	Acabado Finish	
991.1134V	negro cepillado/brushed black	1/15
991.1135V	latón cava/champagne brass	1/15
991.1136V	bronce cepillado/brushed bronze	1/15

HINOKI WOOD

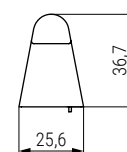
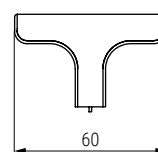
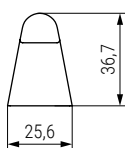
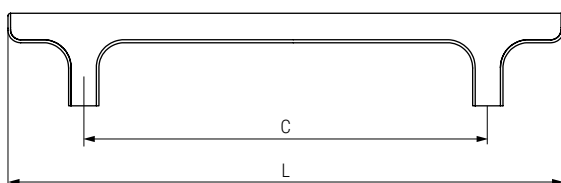

Código Code	C	L	Acabado Finish	
991.1116	160	220	roble/oak	1/25
991.1117	160	220	nogal/walnut	1/25
991.1118V	160	220	roble crudo/raw oak	1/25

Código Code	Acabado Finish	
991.1113	roble/oak	1/25
991.1114	nogal/walnut	1/25
991.1115V	roble crudo/raw oak	1/25



HINOKI WOOD BIG

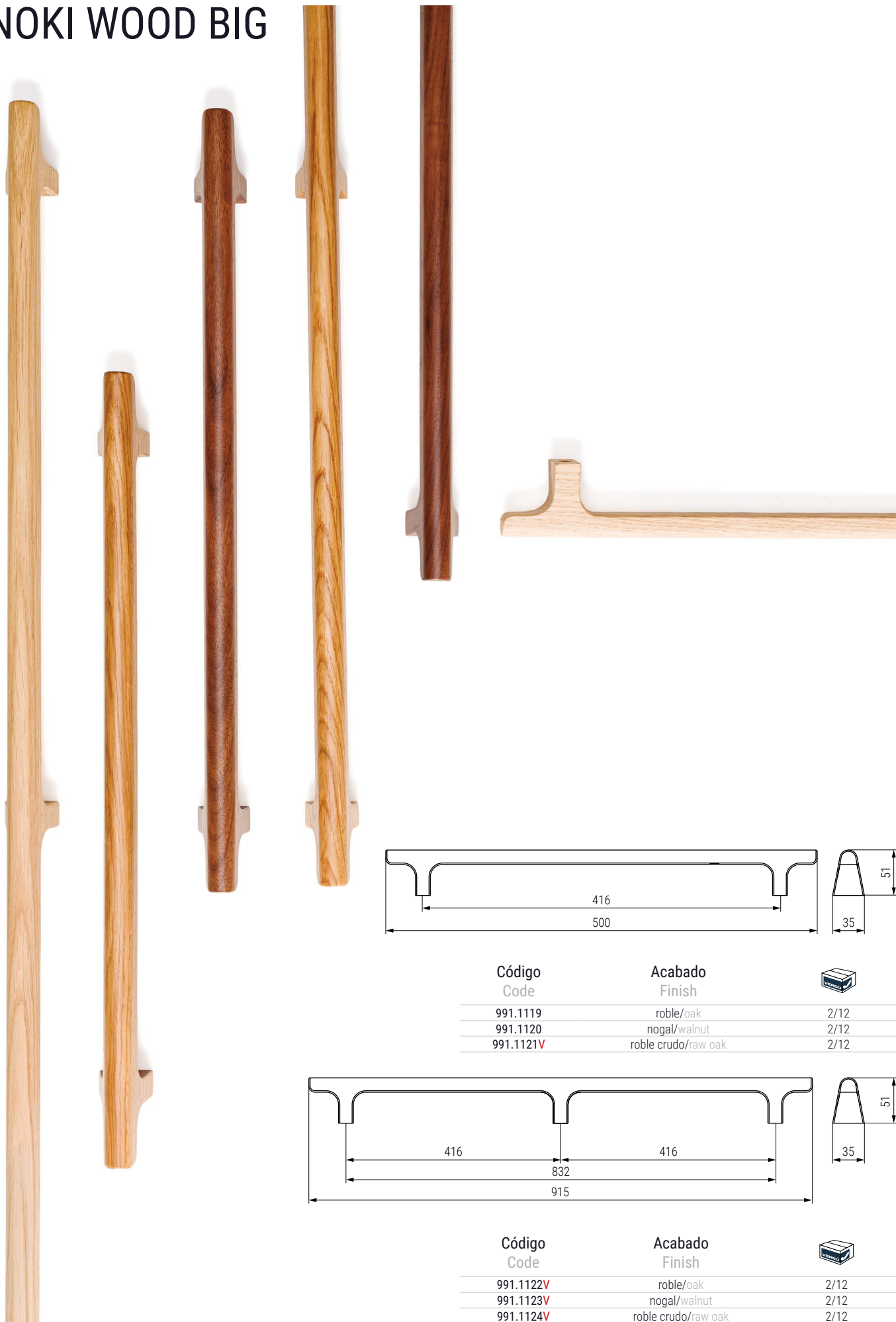



Código Code	Acabado Finish	
991.1119	roble/oak	2/12
991.1120	nogal/walnut	2/12
991.1121V	roble crudo/raw oak	2/12

Código Code	Acabado Finish	
991.1122V	roble/oak	2/12
991.1123V	nogal/walnut	2/12
991.1124V	roble crudo/raw oak	2/12

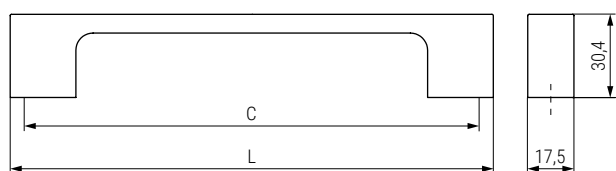

LUV



Código Code	C	L	Acabado Finish	
991.992	192	202	níquel cepillado/brushed nickel	1/25
991.994	192	202	latón cava cepillado/brushed polished brass	1/25
991.996	192	202	blanco mate/matt white	1/25
991.998	192	202	negro mate /matt black	1/25
991.1226	192	202	bronce cepillado/brushed bronze	1/25
991.993V	320	330	níquel cepillado/brushed nickel	1/25
991.995	320	330	latón cava cepillado/brushed polished brass	1/25
991.997	320	330	blanco mate/matt white	1/25
991.999	320	330	negro mate /matt black	1/25
991.1227	320	330	bronce cepillado/brushed bronze	1/25

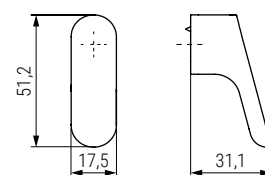



Código Code	Acabado Finish	
991.988	níquel cepillado/brushed nickel	1/25
991.989	latón cava cepillado/brushed polished brass	1/25
991.990	blanco mate/matt white	1/25
991.991	negro mate/matt black	1/25
991.1225	bronce cepillado/brushed bronze	1/25

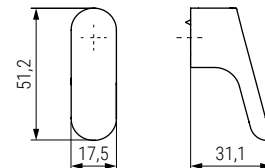
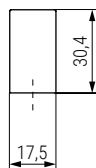
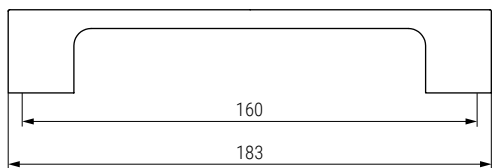

LUV WOOD



Código Code	Acabado Finish	
991.1151	roble/oak	1/25
991.1152	nogal/walnut	1/25
991.1153V	negro/black	1/25

Código Code	Acabado Finish	
991.1148	roble/oak	1/25
991.1149	nogal/walnut	1/25
991.1150V	negro/black	1/25



LUV BIG



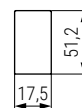
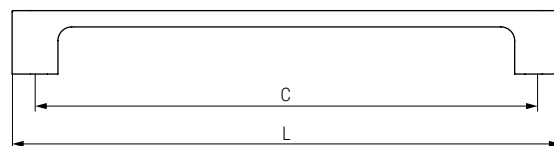

Código Code	C	L	Acabado Finish	
991.1213	384	419	broce cepillado/brushed bronze	2
991.1215	384	419	blanco mate/matt white	2
991.1217	384	419	negro mate/matt black	2





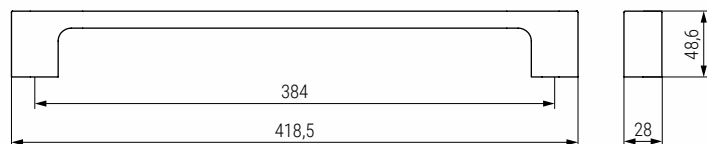

LUV WOOD

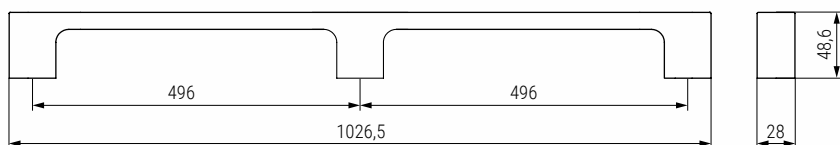

Código Code	Material	Acabado Finish	
991.1047	madera/wood	roble/oak	2
991.1053	madera/wood	nogal/walnut	2
991.1079	madera/wood	negro/black	2



Código Code	Material	Acabado Finish	
991.1050V	madera/wood	roble/oak	2
991.1056V	madera/wood	nogal/walnut	2



FASE

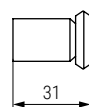

Código
Code

Acabado
Finish



991.1175	PVD negro titanio brillo/PVD polished titanium black	1/25
991.1179V	latón cava cepillado/brushed champagne brass	1/25
991.1183	bronce cepillado/brushed bronze	1/25

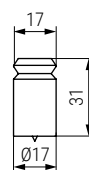
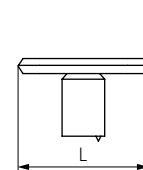

Código
Code

Acabado
Finish



991.1176	PVD negro titanio brillo/PVD polished titanium black	1/25
991.1180	latón cava cepillado/brushed champagne brass	1/25
991.1184	bronce cepillado/brushed bronze	1/25

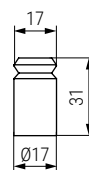
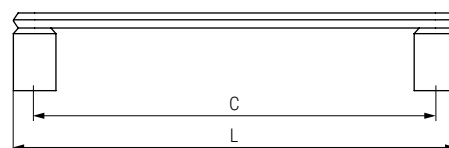

Código
Code

C

L

Acabado
Finish



991.1177	160	177	PVD negro titanio brillo/PVD polished titanium black	1/25
991.1181	160	177	latón cava cepillado/brushed champagne brass	1/25
991.1185	160	177	bronce cepillado/brushed bronze	1/25
991.1178	320	337	PVD negro titanio brillo/PVD polished titanium black	1/25
991.1182	320	337	latón cava cepillado/brushed champagne brass	1/25
991.1186	320	337	bronce cepillado/brushed bronze	1/25



FASE BIG





Código Code	C	L	Acabado Finish	
991.1197V	320	348	PVD negro titanio brillo/PVD polished titanium black	2
991.1201V	320	348	latón cava cepillado/brushed champagne brass	2
991.1205V	320	348	bronce cepillado/brushed bronze	2
991.1198V	480	508	PVD negro titanio brillo/PVD polished titanium black	2
991.1202V	480	508	latón cava cepillado/brushed champagne brass	2
991.1206V	480	508	bronce cepillado/brushed bronze	2





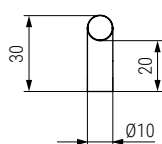
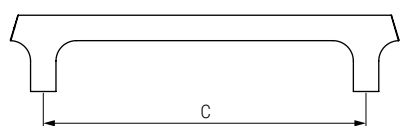

KAIRIS

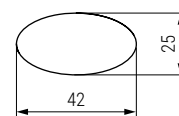
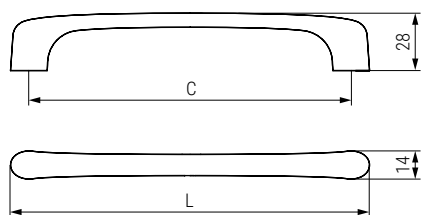

Código Code	C	L	Acabado Finish	
9042.157	128	153	niquel cepillado/brushed nickel	1/50
9042.158	128	153	negro mate/matt black	1/50
9042.159	128	153	mocca gold/mocha gold	1/50
9042.160	192	217	niquel cepillado/brushed nickel	1/50
9042.161	192	217	negro mate/matt black	1/50
9042.162	192	217	mocca gold/mocha gold	1/50

ELIO





Código Code	C	L	Acabado Finish	
544.852	160	178	oro satinado/satin gold	1/25
544.855	160	178	negro mate/matt black	1/25
544.858	160	178	bronce/bronze	1/25
544.853	320	338	oro satinado/satin gold	1/25
544.856	320	338	negro mate/matt black	1/25
544.859	320	338	bronce/bronze	1/25

Código Code	Acabado Finish	
544.851	oro satinado/ satin gold	1/25
544.854	negro mate/matt black	1/25
544.857	bronce/bronze	1/25

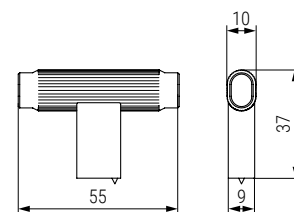
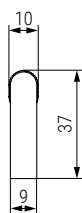
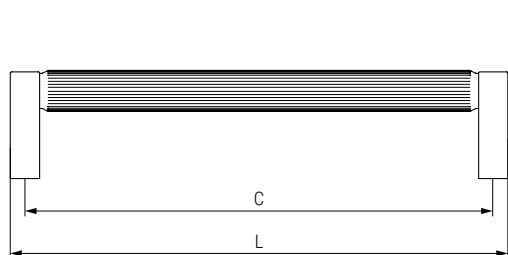
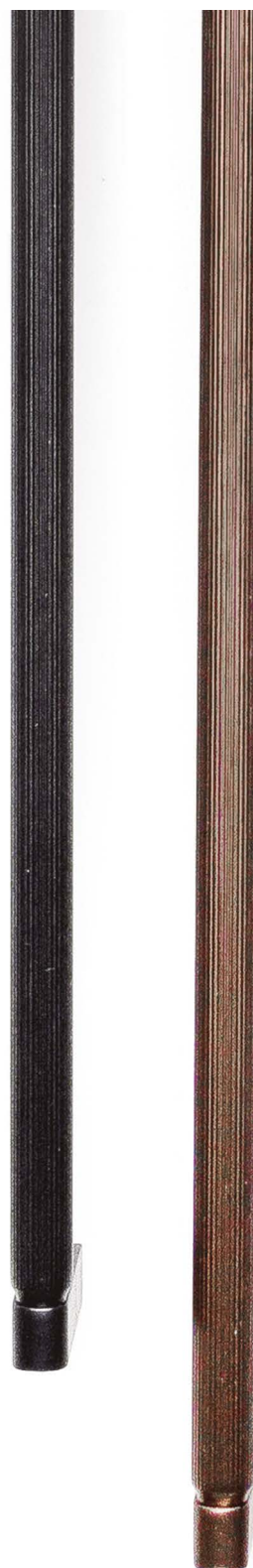

BROOKLYN



Código Code	C	L	Acabado Finish	
991.1109	160	170	negro cepillado/brushed black	1/25
991.1110	160	170	bronce cepillado/brushed bronze	1/25
991.1111	320	330	negro cepillado/brushed black	1/25
991.1112	320	330	bronce cepillado/brushed bronze	1/25

Código Code	Acabado Finish	
991.1137	negro cepillado/brushed black	1/25
991.1138	bronce cepillado/brushed bronze	1/25



ALAN



Código Code	C	L	Acabado Finish	
544.831	96	108	negro mate /matt black	1/50
544.821	96	108	níquel satinado/satin nickel	1/50
544.826	96	108	oro satinado/satin gold	1/50
544.832	128	140	negro mate /matt black	1/25
544.822	128	140	níquel satinado/satin nickel	1/25
544.827	128	140	oro satinado/satin gold	1/25
544.833	160	172	negro mate /matt black	1/25
544.823	160	172	níquel satinado/satin nickel	1/25
544.828	160	172	oro satinado/satin gold	1/25
544.834	224	236	negro mate /matt black	1/25
544.824	224	236	níquel satinado/satin nickel	1/25
544.829	224	236	oro satinado/satin gold	1/25

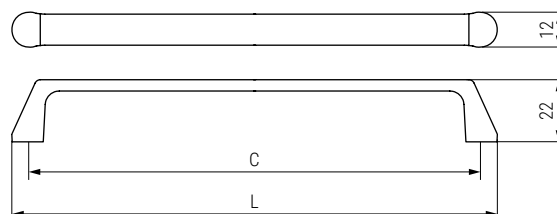

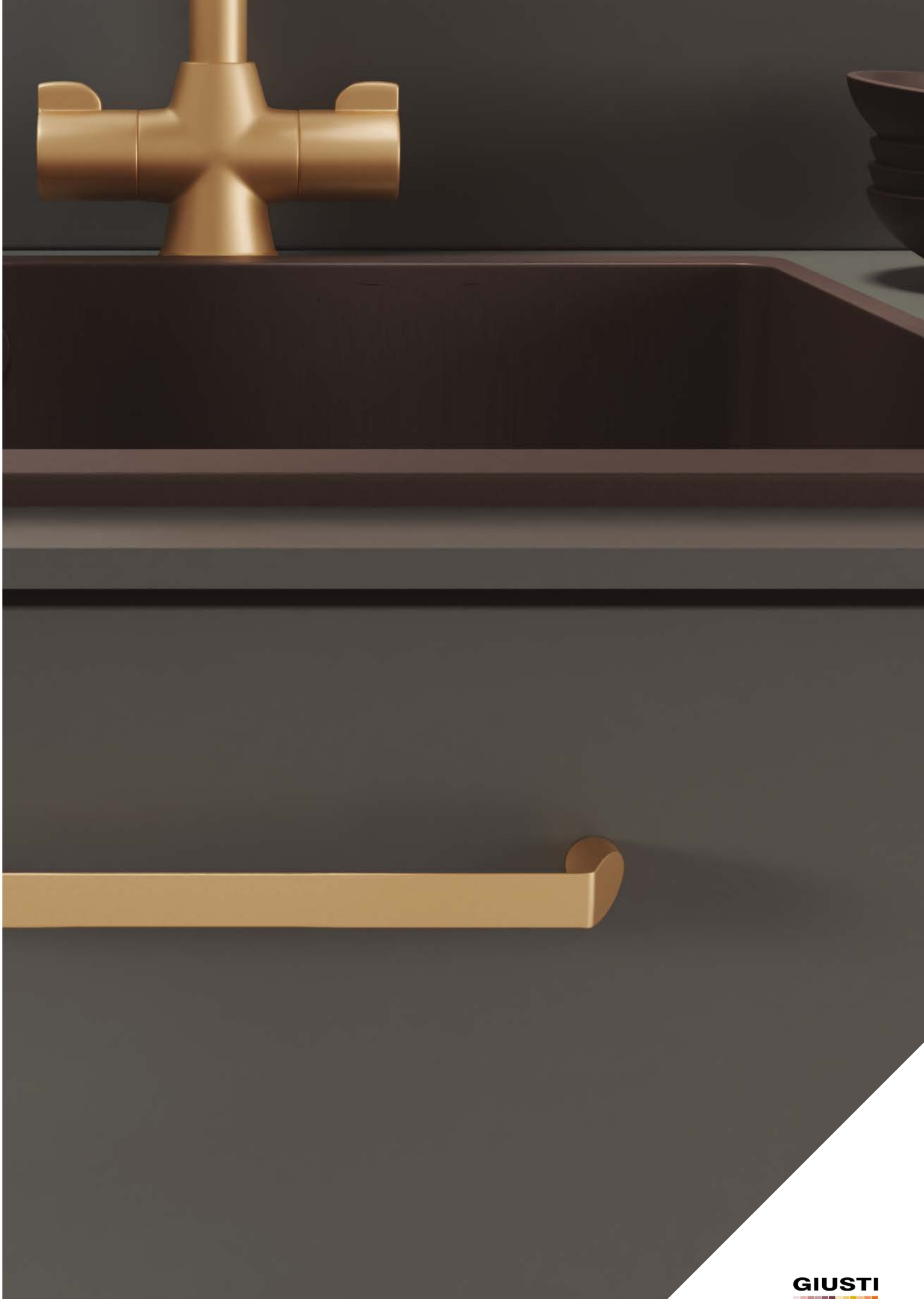



GINO

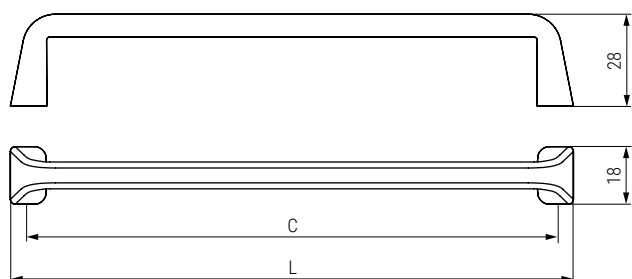

Código Code	C	L	Acabado Finish	
544.841	160	170	oro satinado/satin gold	1/25
544.843	160	170	bronce/bronze	1/25
544.842	224	234	oro satinado/satin gold	1/25
544.844	224	234	bronce/bronze	1/25



DROPP

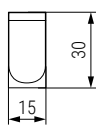
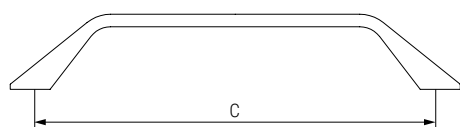

Código Code	C	L	Acabado Finish	
991.1228	64	84	blanco mate/matt white	1/25
991.1230	64	84	negro mate/matt black	1/25
991.1229	160	180	blanco mate/matt white	1/25
991.1231	160	180	negro mate/matt black	1/25

ARKEN



Código Code	C	L	Acabado Finish	
9042.163	128	146	níquel cepillado/brushed nickel	1/50
9042.164	128	146	negro mate/matt black	1/50
9042.165	128	146	antracita/anthracite	1/50
9042.166	192	210	níquel cepillado/brushed nickel	1/25
9042.167	192	210	negro mate/matt black	1/25
9042.168	192	210	antracita/anthracite	1/25

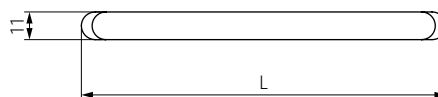
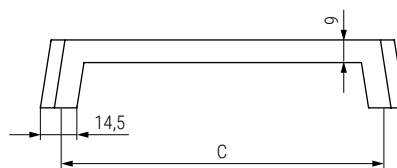

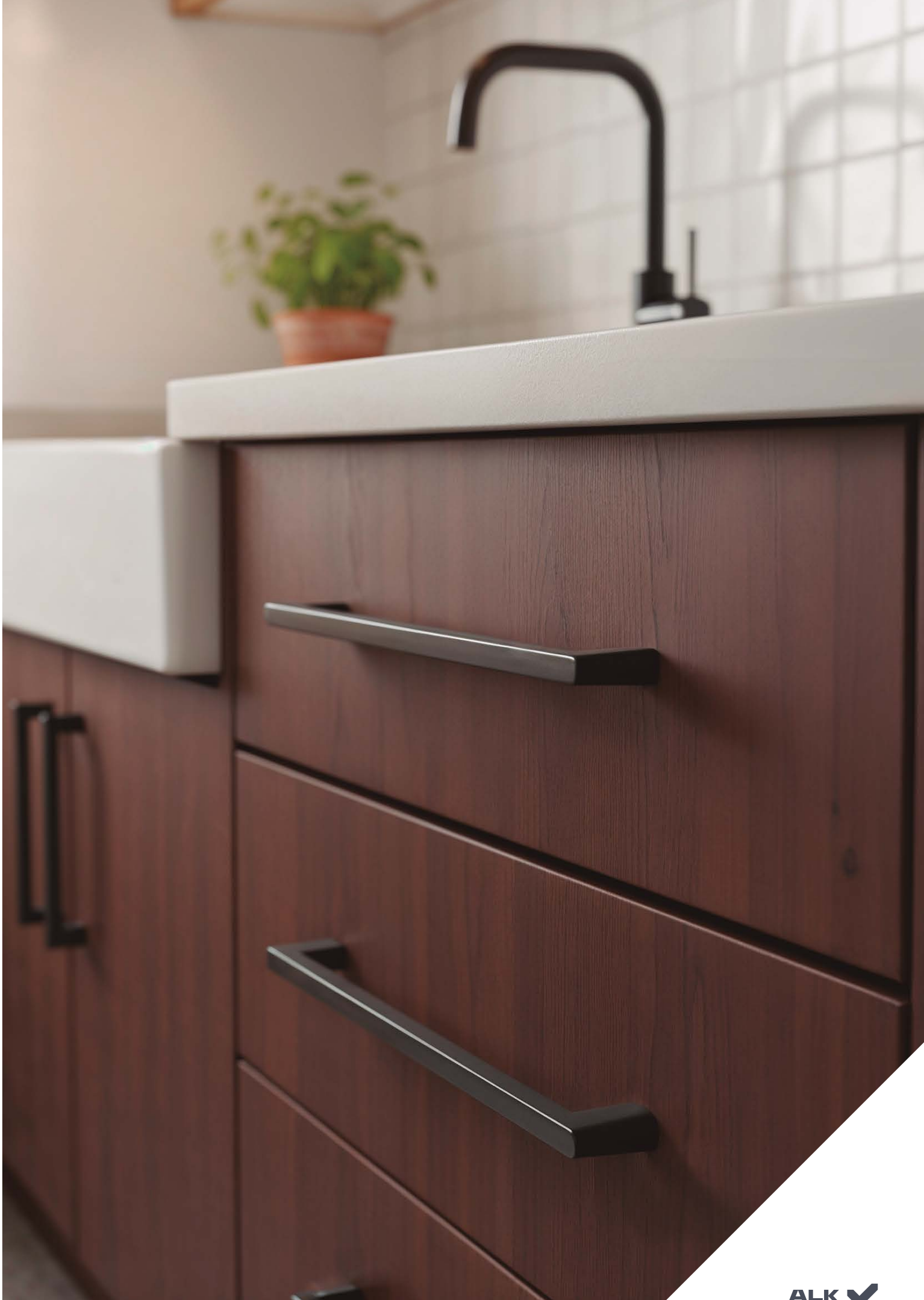



MOON

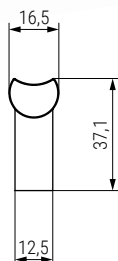
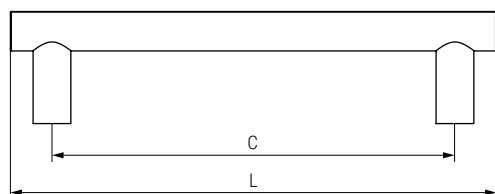

Código Code	C	L	Acabado Finish	
991.1140	160	193	inox look/stainless steel look	1/25
991.1141	160	193	latón cava/brushed brass cava	1/25
991.1142	160	193	negro cepillado/brushed black	1/25
991.1143	160	193	bronce cepillado/brushed bronze	1/25
991.1144	320	353	inox look/stainless steel look	1/25
991.1145	320	353	latón cava/brushed brass cava	1/25
991.1146	320	353	negro cepillado/brushed black	1/25
991.1147	320	353	bronce cepillado/brushed bronze	1/25



LACE

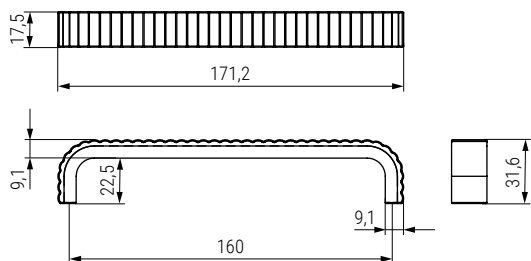
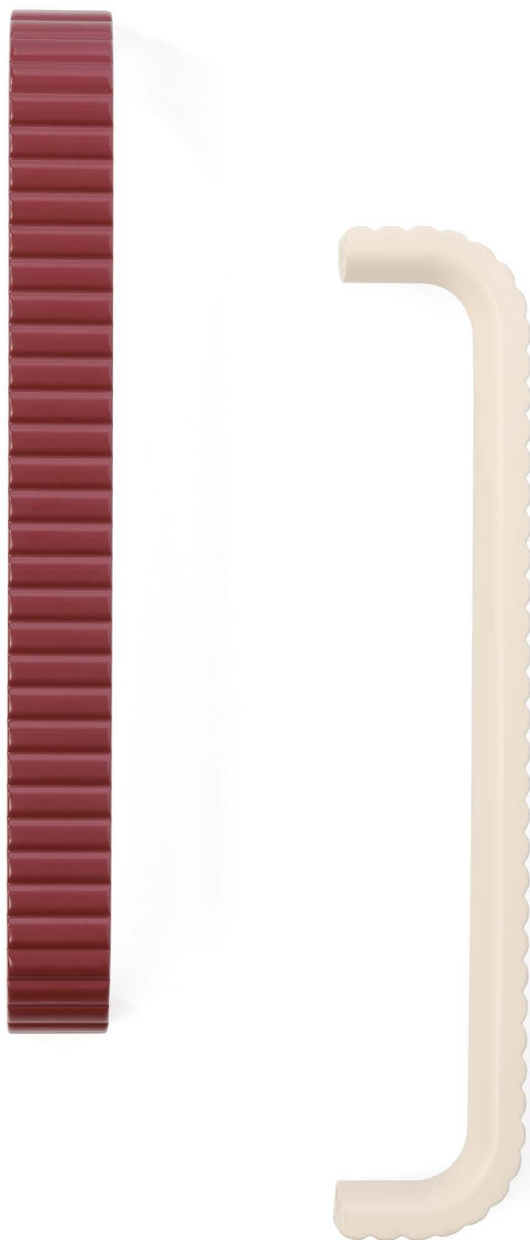

Código Code	Acabado Finish	
553.185	crema/cream	1/50
553.186	rojo granate/burgundy red	1/50

TERRA

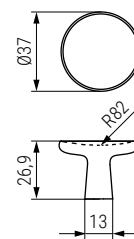
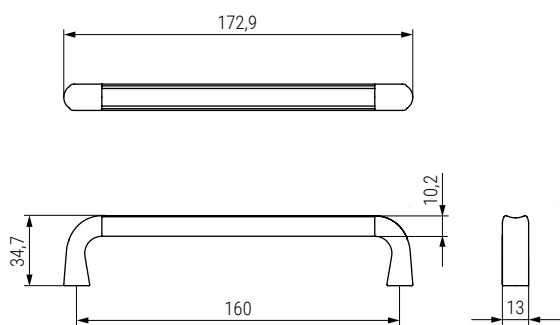

Código Code	Acabado Finish	
553.177	bronce mate/matt bronze	1/100
553.178	inox look/inox look	1/100
553.179	cobre cepillado/brushed copper	1/100

Código Code	Acabado Finish	
553.180	bronce mate/matt bronze	1/100
553.181	inox look/inox look	1/100
553.182	cobre cepillado/brushed copper	1/50



DEL PLÁSTICO OCEÁNICO A LOS TIRADORES PARA MUEBLES

En el corazón de Jutlandia Occidental, se desarrolla una tecnología innovadora para reciclar redes de pesca desechadas, cuerdas y otros residuos plásticos procedentes de la industria marítima.

Gracias a este proceso, nace una colección de tiradores para muebles fabricada con al menos un 90 % de plástico oceánico reciclado, dando una nueva vida a materiales que, de otro modo, terminarían contaminando nuestros océanos. Una colección que combina diseño, funcionalidad y compromiso con la sostenibilidad.

FROM OCEAN PLASTIC TO FURNITURE HANDLES

In the heart of Western Jutland, an innovative technology is being developed to recycle discarded fishing nets, ropes, and other plastic waste from the maritime industry.

Thanks to this process, a collection of furniture handles made from at least 90% recycled ocean plastic is created, giving a new life to materials that would otherwise end up polluting our oceans. A collection that combines design, functionality, and a commitment to sustainability.



UN VIAJE CIRCULAR

Los océanos del mundo están bajo presión debido al creciente problema de los residuos plásticos. Cada año, millones de toneladas de plástico terminan en el mar, procedentes en gran parte de una gestión inadecuada de residuos y de materiales desechados por la industria marítima, como redes de pesca y cuerdas.

Estos residuos representan una seria amenaza para los ecosistemas marinos, la fauna y el equilibrio natural de nuestros océanos.

A través de procesos avanzados de reciclaje y transformación, este plástico recuperado se convierte en materia prima de alta calidad, utilizada para fabricar tiradores con un diseño actual y un enfoque más sostenible.



A CIRCULAR JOURNEY

The world's oceans are under pressure due to the growing problem of plastic waste. Every year, millions of tons of plastic end up in the sea, much of it coming from poor waste management and discarded materials from the maritime industry, such as fishing nets and ropes.

This waste represents a serious threat to marine ecosystems, wildlife, and the natural balance of our oceans.

Through advanced recycling and transformation processes, the recovered plastic is converted into high-quality raw material used to manufacture furniture handles with contemporary design and a more sustainable approach.

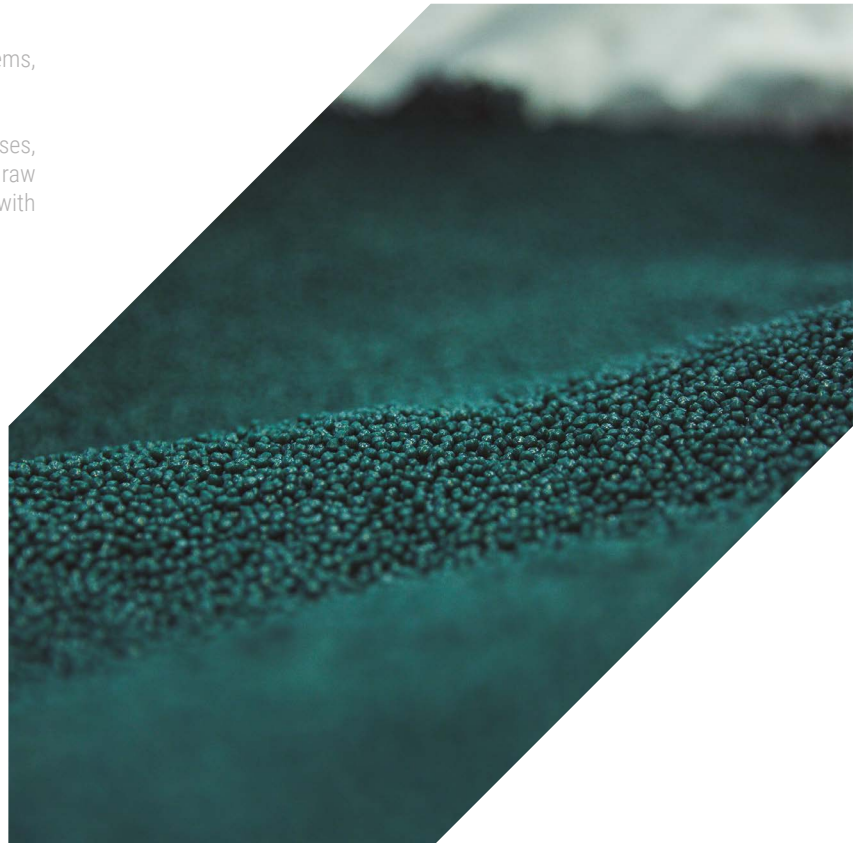



VOLUMI

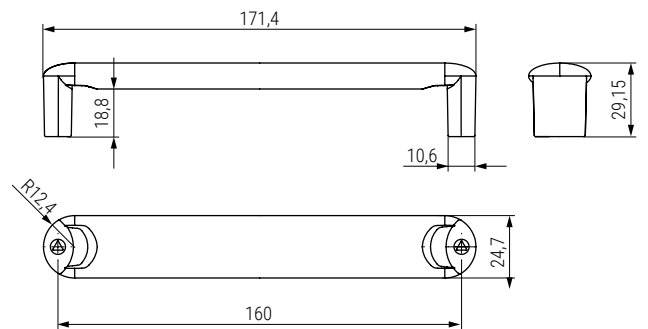
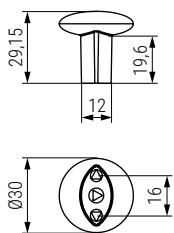



Código Code	Acabado Finish	
553.174	gris/grey	1/50
553.175	negro/black	1/50
553.176	rojo granate/burgundy red	1/50

Código Code	Acabado Finish	
553.171	gris/grey	1/50
553.172	negro/black	1/50
553.173	rojo granate/burgundy red	1/50

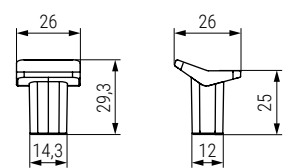
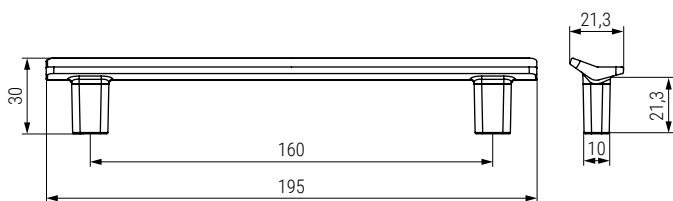
VIS A VIS



Código Code	Acabado Finish	
553.165	latón cepillado/brushed brass	1/50
553.166	negro titanio/titanium black	1/50
553.167	inox look/inox look	1/50

Código Code	Acabado Finish	
553.168	latón cepillado/brushed brass	1/100
553.169	negro titanio/titanium black	1/100
553.170	inox look/inox look	1/100





RACE

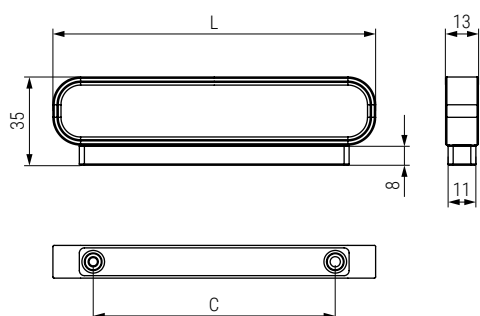

Código Code	C	L	Acabado Finish	
553.161	32	64	roble-negro mate/oak-matt black	1/50
553.163	32	64	marron-laton cepilado/brown-brushed brass	1/50
553.162	96	128	roble-negro mate/oak-matt black	1/50
553.164	96	128	marron-laton cepilado/brown-brushed brass	1/50

LOUNGE



Código Code	Acabado Finish	
553.157	negro mate/matt black	1/100
553.158	níquel satinado/nickel satin	1/50
553.159	latón patinado/patinated brass	1/50
553.160	latón cepilado/brushed brass	1/50

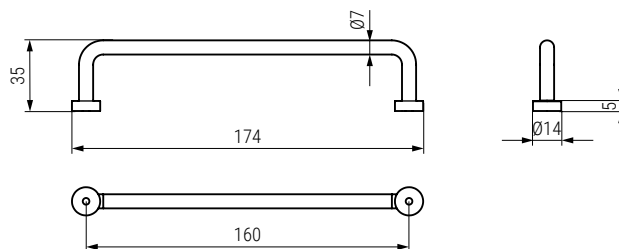





MIRO

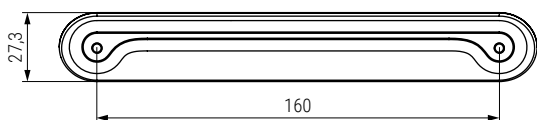
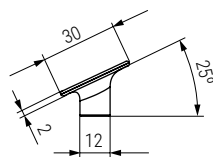
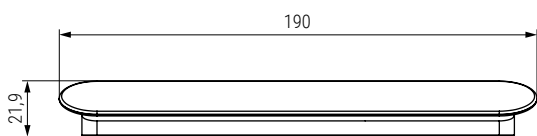

Código
Code

Acabado
Finish



553.155
553.156

negro mate/matt black
beige arizona/arizona beige

1/100
1/100

KORAI

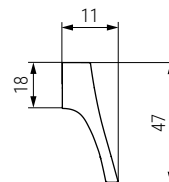
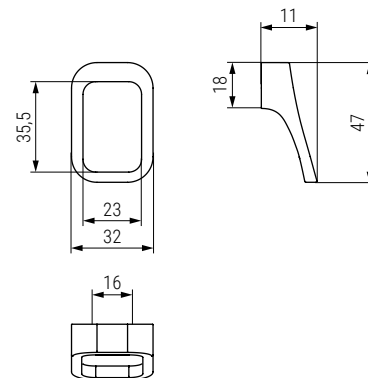
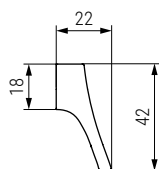
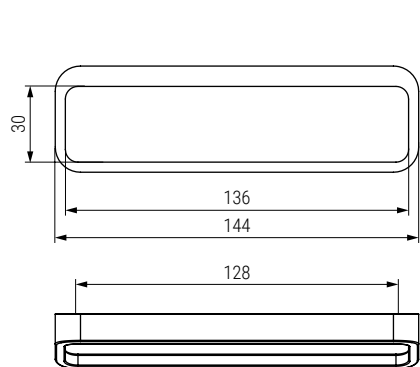
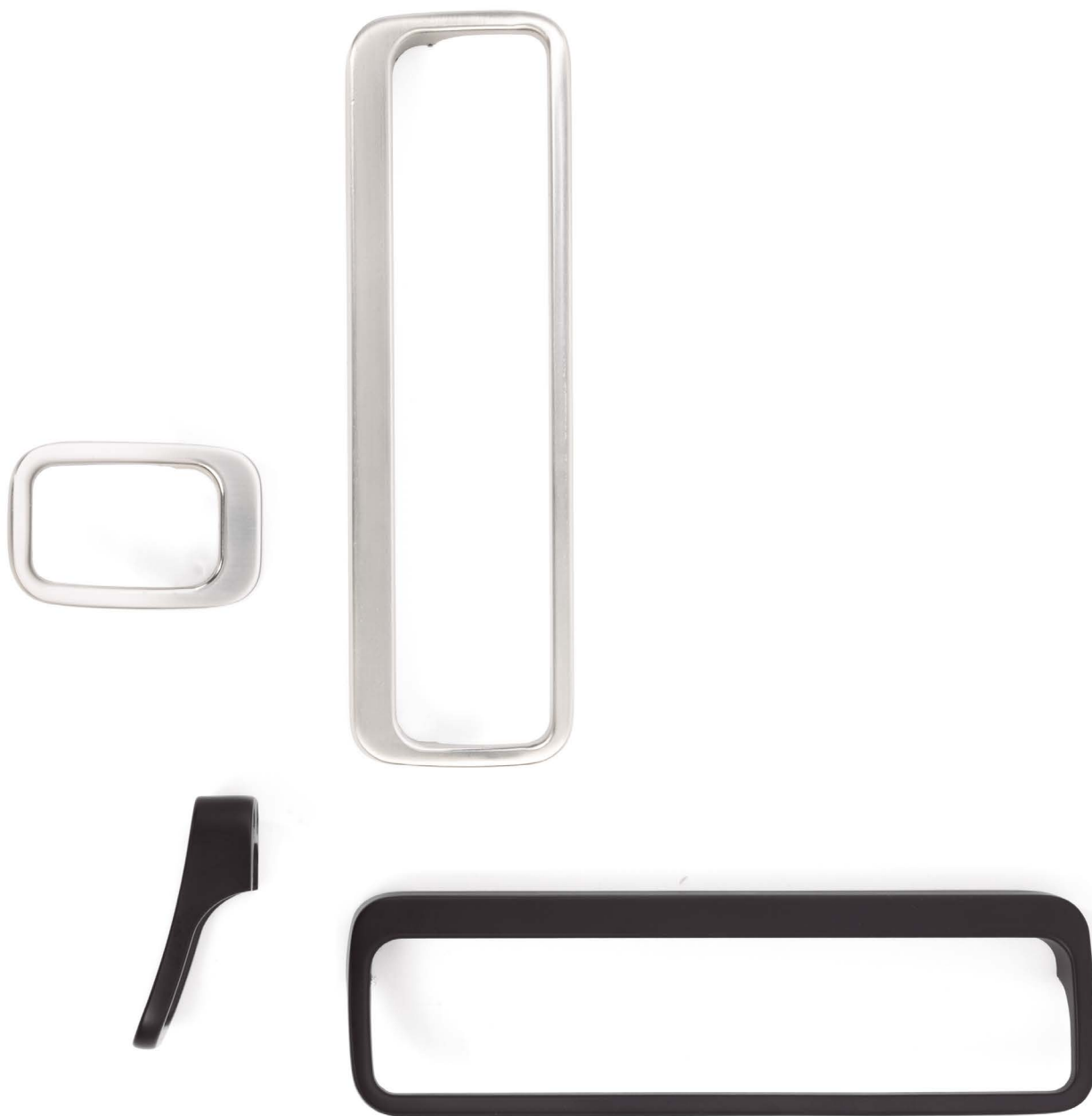

Código
Code

Acabado
Finish



9042.171
9042.172

níquel cepillado/brushed nickel
negro mate/matt black

1/40
1/40

Código
Code

Acabado
Finish



9042.169
9042.170

níquel cepillado/brushed nickel
negro mate/matt black

1/50
1/50



KENSI



Código Code	Acabado Finish	
9042.206	níquel cepillado/brushed nickel	1/50
9042.207	negro cepillado/brushed black	1/50

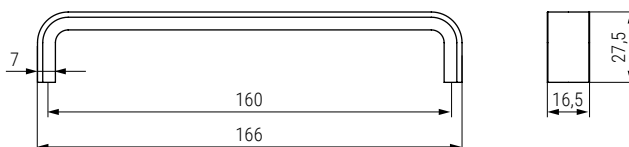





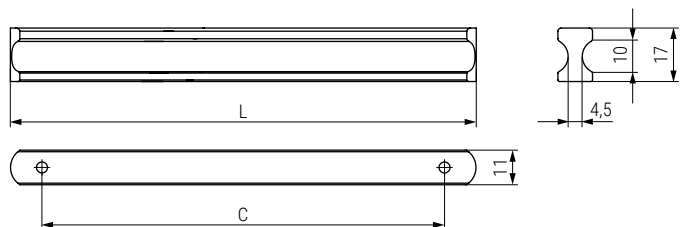

YOKK

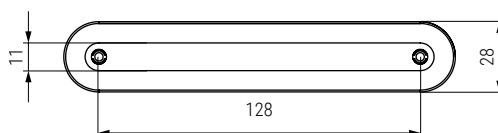
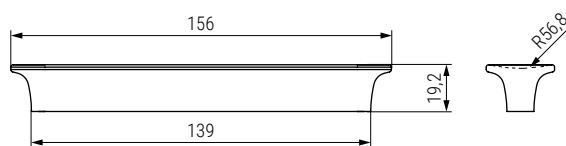

Código Code	C	L	Acabado Finish	
9042.191	64	100	plata mate/matt silver	1/50
9042.196	64	100	negro mate/matt black	1/50
9042.193	128	160	plata mate/matt silver	1/40
9042.198	128	160	negro mate/matt black	1/40

TUBA WOOD



Código Code	Acabado Finish	
553.189	roble/oak	1/50
553.190	nogal/walnut	1/50





TWIST WOOD

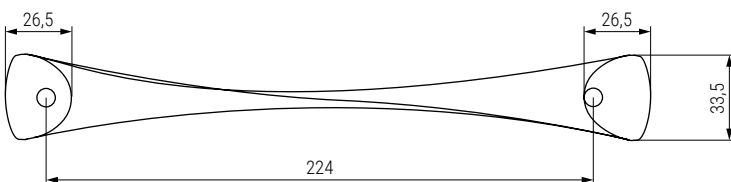
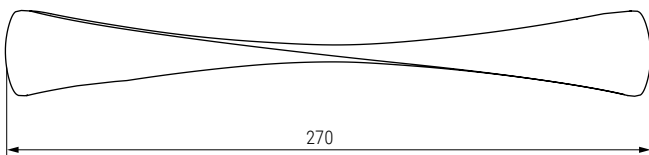

Código
Code
553.191

Acabado
Finish
roble/oak



1/50



JAPAN WOOD

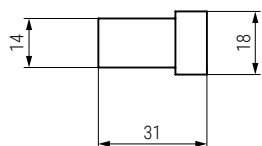
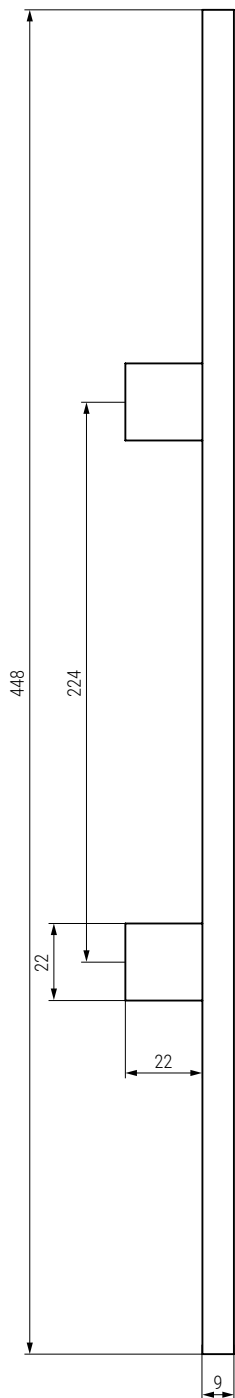

Código
Code

Acabado
Finish



553.192
553.193

roble/oak
nogal/walnut

1/50
1/50



GRAPE WOOD

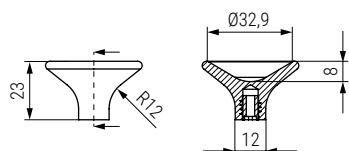

Código
Code

Acabado
Finish



553.194
553.195

roble/oak
nogal/walnut

1/100
1/50

KLOP



Código Code	Acabado Finish	
9042.182	niquel cepillado/brushed nickel	1/50
9042.183	negro mate/matt black	1/50
9042.184	mocca gold/mocha gold	1/50
9042.185	antracita/anthracite	1/50
9042.186	oro satinado/satin gold	1/50

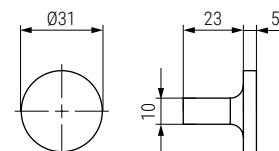

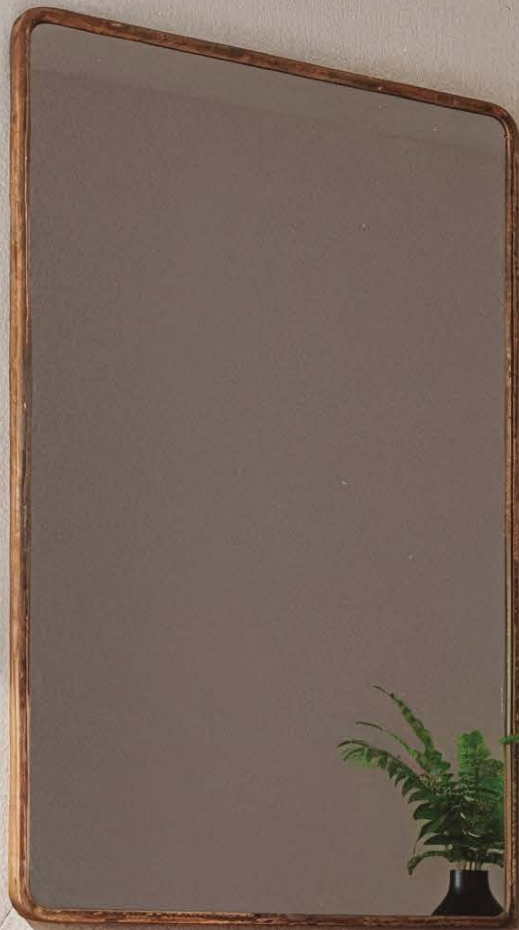



BEAM

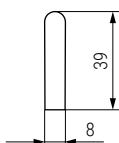
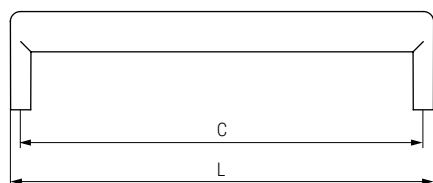

Código Code	C	L	Acabado Finish	
991.1105	160	168	latón cava cepillado/brushed brass cava	1/25
991.1106	160	168	negro mate/matt black	1/25
991.1107	320	328	latón cava cepillado/brushed brass cava	1/25
991.1108	320	328	negro mate/matt black	1/25



ASTOR

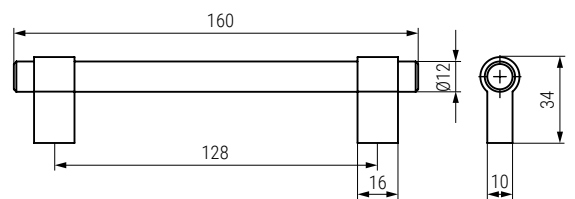
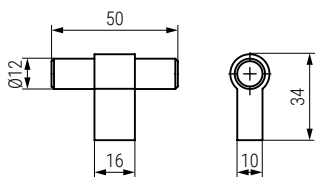

Código
Code

9042.187

Acabado
Finish

negro mate/matt black



1/50

Código
Code

9042.188

Acabado
Finish

negro mate/matt black



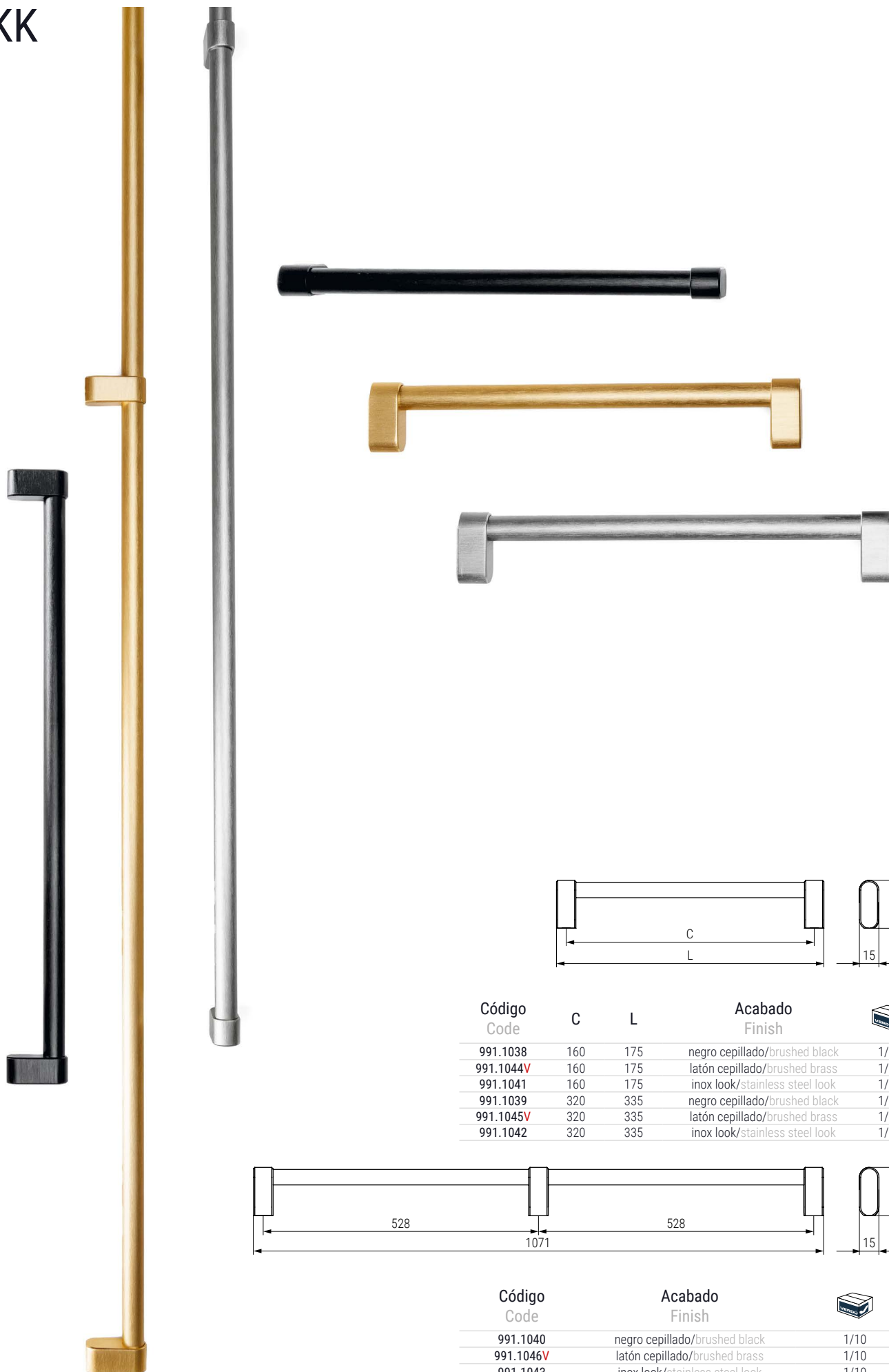

1/25

LINKK

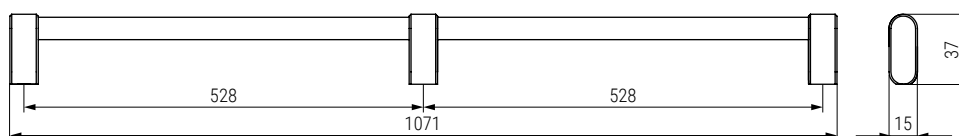

Código Code	C	L	Acabado Finish	
991.1038	160	175	negro cepillado/brushed black	1/25
991.1044V	160	175	latón cepillado/brushed brass	1/25
991.1041	160	175	inox look/stainless steel look	1/25
991.1039	320	335	negro cepillado/brushed black	1/25
991.1045V	320	335	latón cepillado/brushed brass	1/25
991.1042	320	335	inox look/stainless steel look	1/25





Código Code	Acabado Finish	
991.1040	negro cepillado/brushed black	1/10
991.1046V	latón cepillado/brushed brass	1/10
991.1043	inox look/stainless steel look	1/10

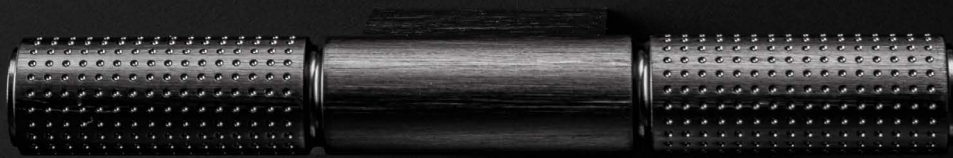

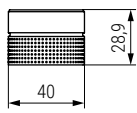

POINT



Código Code	Acabado Finish	
991.1034	negro cepillado/brushed black	1/25
991.1154	latón cava cepilado/brushed brass cava	1/25

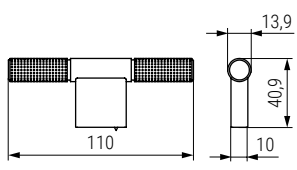

Código Code	Acabado Finish	
991.1035	negro cepillado/brushed black	1/25
991.1155	latón cava cepilado/brushed brass cava	1/25

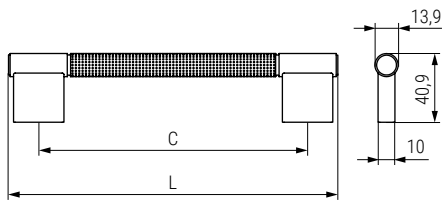

Código Code	C	L	Acabado Finish	
991.1036	192	228	negro cepillado/brushed black	1/25
991.1061V	192	228	latón cava cepilado/brushed brass cava	1/25
991.1059V	320	356	negro cepillado/brushed black	1/25
991.1062V	320	356	latón cava cepilado/brushed brass cava	1/25

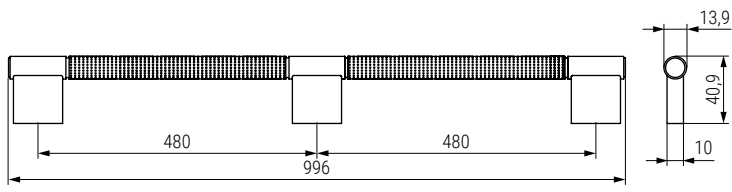

Código Code	Acabado Finish	
991.1037	negro cepillado/brushed black	1/10
991.1156	latón cava cepilado/brushed brass cava	1/10



DUO MINI



Código Code	C	L	Acabado Finish	
991.1010V	160	194,6	roble-antracita/anthracite-oak	1/25
991.1012V	160	194,6	nogal-antracita/anthracite-walnut	1/25
991.1014V	160	194,6	negro-antracita/ anthracite-black	1/25
991.1011V	320	354,6	roble-antracita/anthracite-oak	1/25
991.1013V	320	354,6	nogal-antracita/anthracite-walnut	1/25
991.1015V	320	354,6	negro-antracita/ anthracite-black	1/25

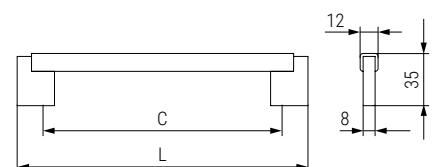

DUO BIG

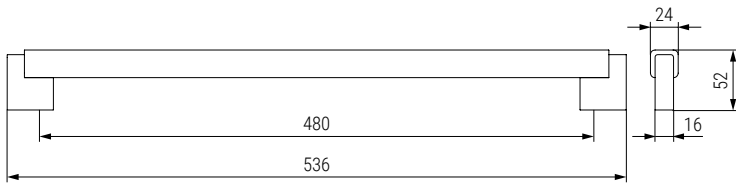
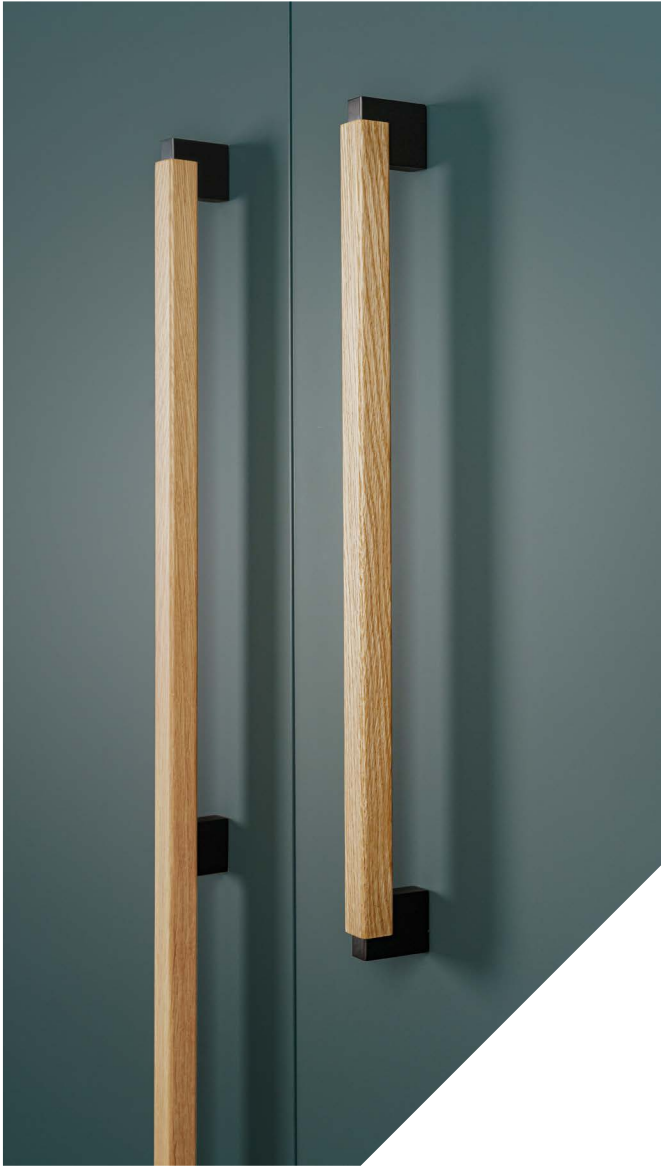

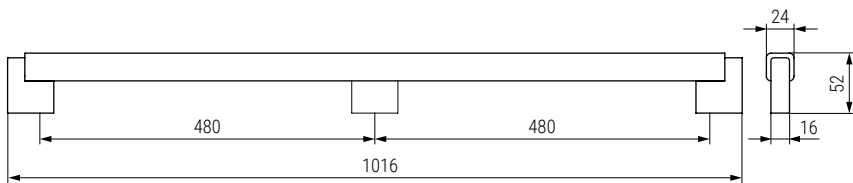

Código Code	Acabado Finish	
991.1016V	roble-antracita/anthracite-oak	2
991.1018V	nogal-antracita/anthracite-walnut	2
991.1020V	negro-antracita/ anthracite-black	2

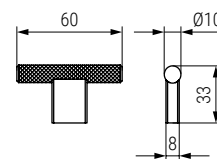
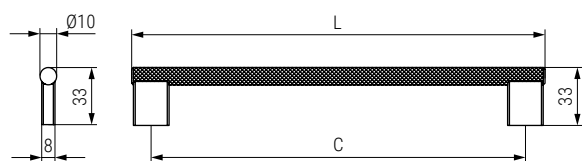

Código Code	Acabado Finish	
991.1017V	roble-antracita/anthracite-oak	2
991.1019V	nogal-antracita/anthracite-walnut	2
991.1021V	negro-antracita/ anthracite-black	2

GRAF MINI



Código Code	C	L	Acabado Finish	
991.401	160	182	latón cepillado/brushed brass	1/25
991.402	160	182	negro cepillado/brushed black	1/25
991.403V	160	182	inox look/stainless steel look	1/25
991.404	256	278	latón cepillado/brushed brass	1/25
991.405	256	278	negro cepillado/brushed black	1/25
991.406V	256	278	inox look/stainless steel look	1/25

Código Code	Acabado Finish	
991.407	latón cepillado/brushed brass	1/25
991.408	negro cepillado/brushed black	1/25
991.409	inox look/stainless steel look	1/25

GRAF BIG

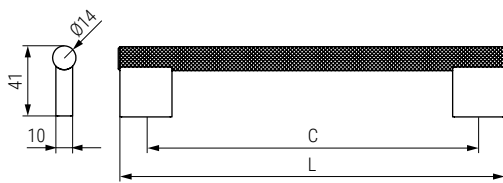

Código Code	C	L	Acabado Finish	
991.376V	192	224	latón cepillado/brushed brass	1/25
991.377	192	224	negro cepillado/brushed black	1/25
991.378V	192	224	inox look/stainless steel look	1/25
991.457V	320	352	latón cepillado/brushed brass	1/25
991.458	320	352	negro cepillado/brushed black	1/25
991.459V	320	352	inox look/stainless steel look	1/25

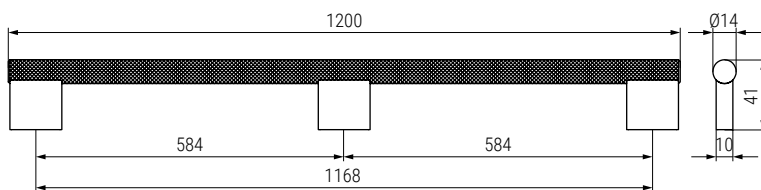

Código Code	Acabado Finish	
991.336V	latón cepillado/brushed brass	1/10
991.337	negro cepillado/brushed black	1/10
991.338V	inox look/stainless steel look	1/10

RILLE

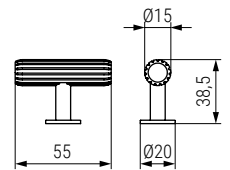
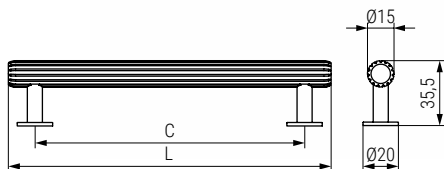

Código
Code

Acabado
Finish



991.921	inox look/stainless steel look	1/25
991.922	latón cepillado/brushed brass	1/25
991.923	negro cepillado/brushed black	1/25

Código Code	C	L	Acabado Finish	
991.924	160	190	inox look/stainless steel look	1/25
991.925	160	190	latón cepillado/brushed brass	1/25
991.926	160	190	negro cepillado/brushed black	1/25
991.927	320	350	inox look/stainless steel look	1/25
991.928	320	350	latón cepillado/brushed brass	1/25
991.929	320	350	negro cepillado/brushed black	1/25
991.930	480	510	inox look/stainless steel look	1/25
991.931	480	510	latón cepillado/brushed brass	1/25
991.932	480	510	negro cepillado/brushed black	1/25

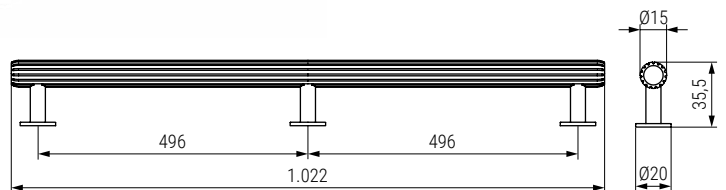

Código
Code

Acabado
Finish



991.933	inox look/stainless steel look	1/15
991.934	latón cepillado/brushed brass	1/15
991.935	negro cepillado/brushed black	1/15



RISS MINI



Código Code	C	L	Acabado Finish	
991.1023	192	207	blanco mate/matt white	1/25
991.1025	192	207	negro mate/matt black	1/25
991.1027	192	207	verde forest/forest green	1/25
991.1024	320	335	blanco mate/matt white	1/25
991.1026	320	335	negro mate/matt black	1/25
991.1028	320	335	verde forest/forest green	1/25

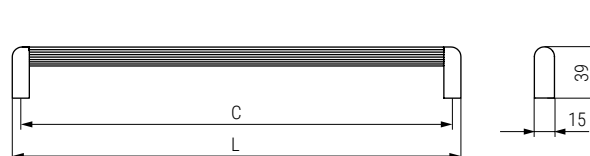

RISS BIG

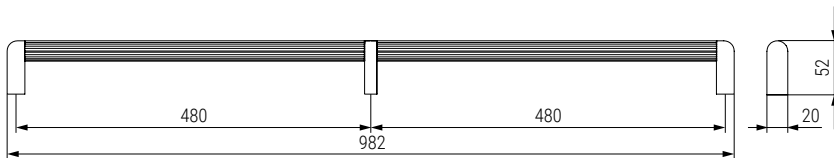

Código Code	Acabado Finish	
991.1022	negro mate/matt black	1/10
991.1069V	blanco mate/matt white	1/10
991.1070V	gris musgo/moss grey	1/10
991.1071V	verde forest/forest green	1/10

BELT

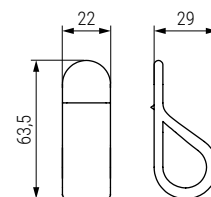
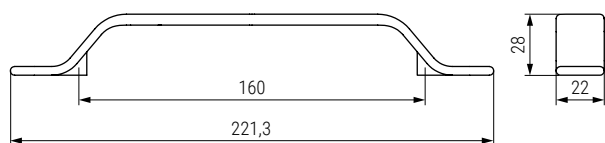

Código Code	Acabado Finish	
991.981	blanco mate/matt white	1/25
991.982	negro mate/matt black	1/25
991.983	gris musgo/moss grey	1/25
991.984V	verde forest/forest green	1/25
991.985V	marrón mocca/mocha brown	1/25
991.986V	rojo vulcano/volcano red	1/25

Código Code	Acabado Finish	
991.975	blanco mate/matt white	1/25
991.976	negro mate/matt black	1/25
991.977	gris musgo/moss grey	1/25
991.978V	verde forest/forest green	1/25
991.979V	marrón mocca/mocha brown	1/25
991.980V	rojo vulcano/volcano red	1/25



CADIER



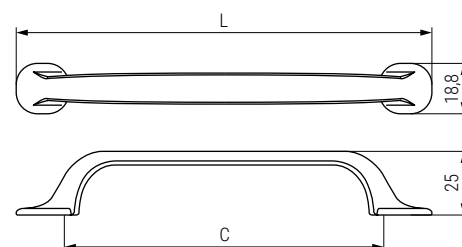

Código Code	C	L	Acabado Finish	
544.655	64	102	negro mate/matt black	1/50
544.665	64	102	oro satinado/satin gold	1/50
544.654	96	134	negro mate/matt black	1/50
544.664	96	134	oro satinado/satin gold	1/50
544.653	128	166	negro mate/matt black	1/25
544.663	128	166	oro satinado/satin gold	1/25
544.652	160	198	negro mate/matt black	1/25
544.662	160	198	oro satinado/satin gold	1/25
544.651	256	294	negro mate/matt black	1/25
544.661	256	294	oro satinado/satin gold	1/25



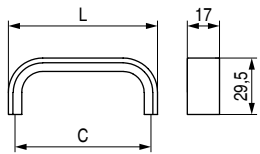

SENSE MINI



Código Code	C	L	Acabado Finish	
991.272	96	103	latón oscuro cepillado/brushed dark brass	1/25
991.271	96	103	negro mate/matt black	1/25
991.576	96	103	inox look/stainless steel look	1/25
991.275	160	167	latón oscuro cepillado/brushed dark brass	1/25
991.274	160	167	negro mate/matt black	1/25
991.577	160	167	inox look/stainless steel look	1/25
991.278	256	263	latón oscuro cepillado/brushed dark brass	1/25
991.277	256	263	negro mate/matt black	1/25
991.578	256	263	inox look/stainless steel look	1/25

SENSE

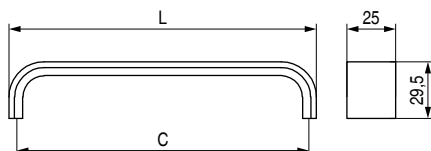

Código Code	C	L	Acabado Finish	
991.205	128	135	inox look/stainless steel look	1/25
991.281	128	135	negro cepillado/brushed black	1/25
991.206	192	199	inox look/stainless steel look	1/25
991.282	192	199	negro cepillado/brushed black	1/25
991.207	320	327	inox look/stainless steel look	1/25
991.283	320	327	negro cepillado/brushed black	1/25
991.208	480	487	inox look/stainless steel look	1/25
991.284	480	487	negro cepillado/brushed black	1/25

NUT



Código Code	C	L	Acabado Finish	
544.763	128	142	grafito/graphite	1/25
544.768	128	142	níquel satinado/satin nickel	1/25
544.762	192	206	grafito/graphite	1/25
544.767	192	206	níquel satinado/satin nickel	1/25
544.761	320	334	grafito/graphite	1/15
544.766	320	334	níquel satinado/satin nickel	1/15

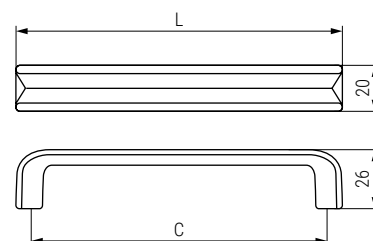

RIOLITA

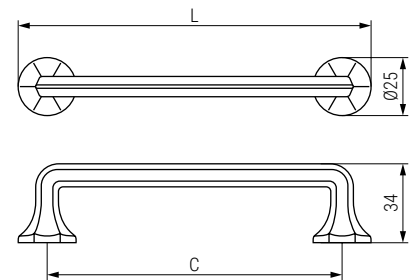
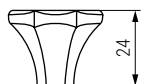
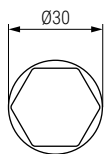



Código Code	Acabado Finish	
544.639	negro mate/matt black	1/50

Código Code	C	L	Acabado Finish	
544.638	128	153	negro mate/matt black	1/25
544.637	160	185	negro mate/matt black	1/25
544.636	320	345	negro mate/matt black	1/25

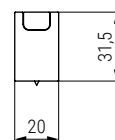
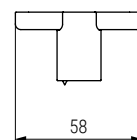
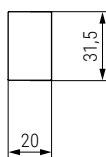
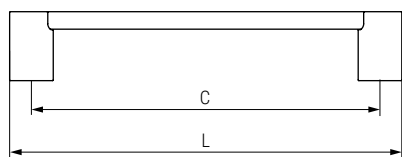
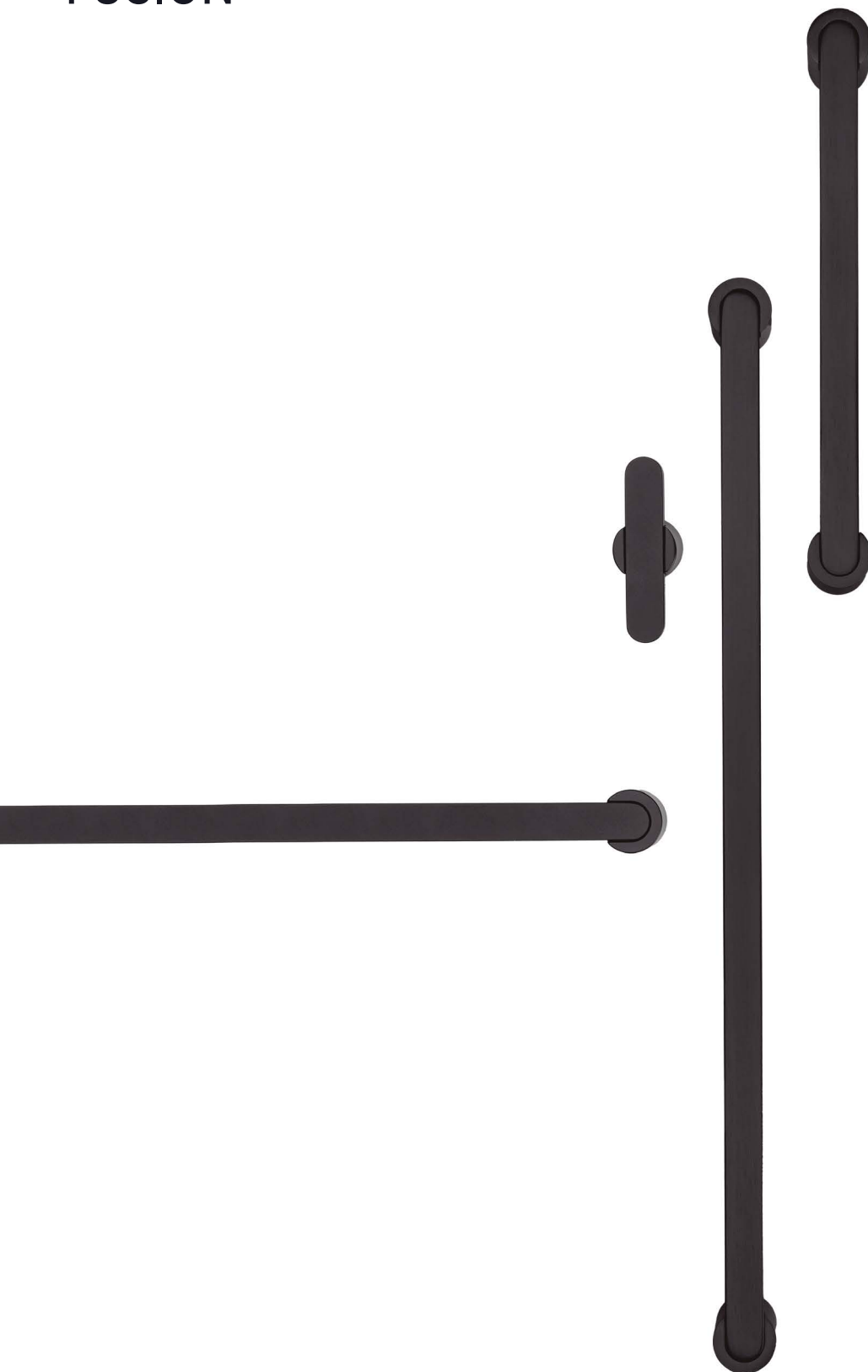
FUSION



Código Code	C	L	Acabado Finish	
991.1030	160	180	negro mate/matt black	1/25
991.1031	320	340	negro mate/matt black	1/25

Código Code	Acabado Finish	
991.1029	negro mate/matt black	1/25



CELSO

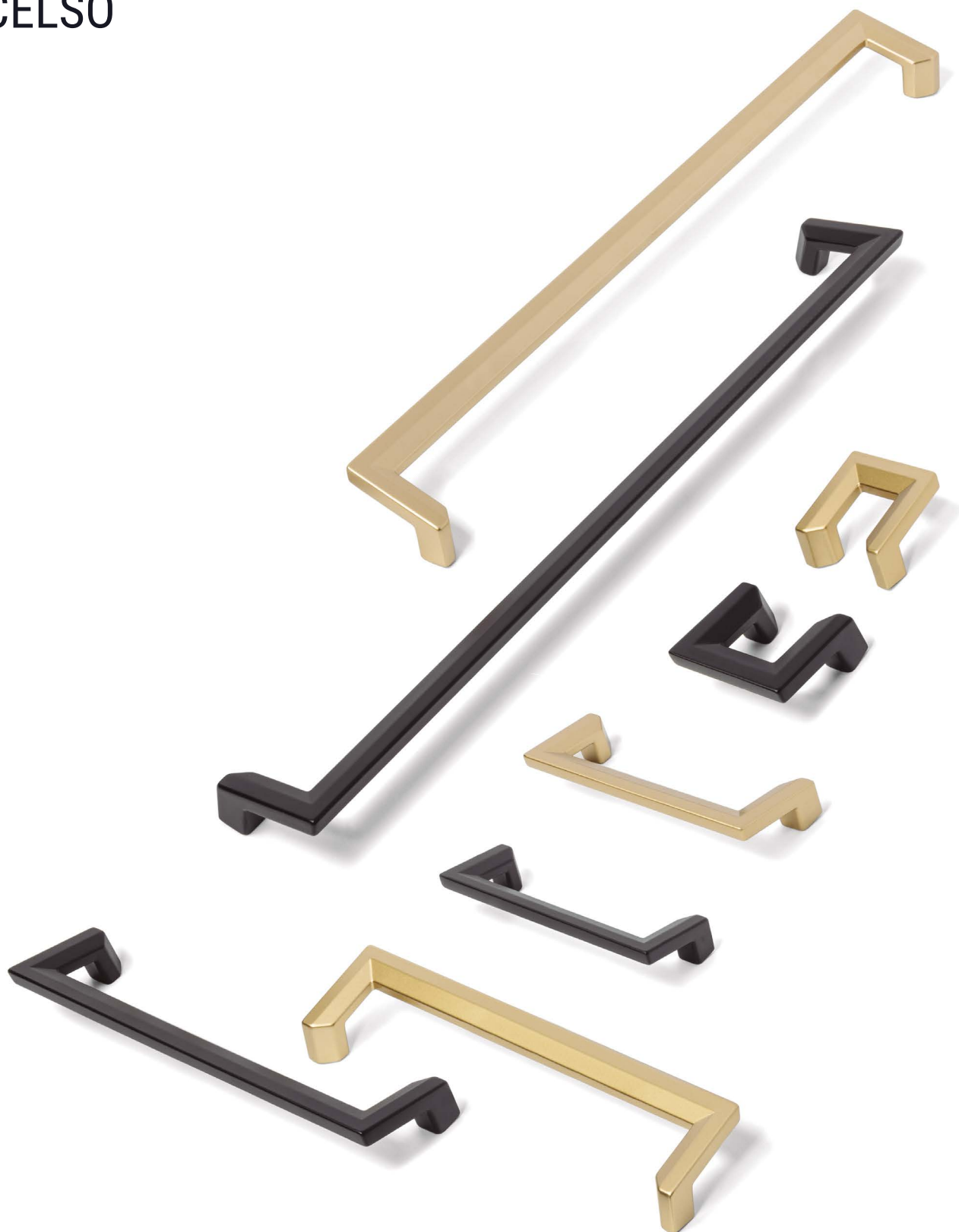

Código Code	C	L	Acabado Finish	
544.811	32	44	negro mate/matt black	1/50
544.816	32	44	oro satinado/satin gold	1/50
544.812	96	108	negro mate/matt black	1/50
544.817	96	108	oro satinado/satin gold	1/50
544.813	160	172	negro mate/matt black	1/25
544.818	160	172	oro satinado/satin gold	1/25
544.814	320	332	negro mate/matt black	1/25
544.819	320	332	oro satinado/satin gold	1/25

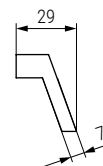
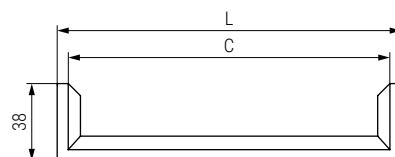



FLOID

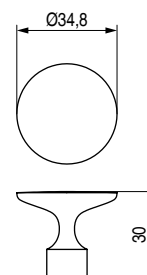
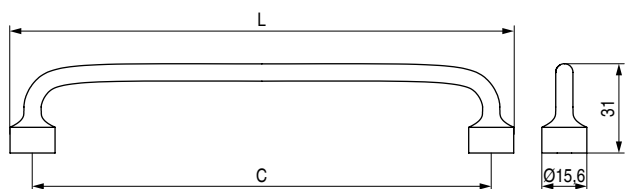

Código Code	C	L	Acabado Finish	
991.699	128	143,6	negro mate/matt black	1/25
991.702	128	143,6	oro cepillado/brushed gold	1/25
991.705V	128	143,6	peltre/pewter	25
991.708	128	143,6	latón antiguo/antique brass	1/25
991.698	192	207,6	negro mate/matt black	1/25
991.701	192	207,6	oro cepillado/brushed gold	1/25
991.704V	192	207,6	peltre/pewter	25
991.707	192	207,6	latón antiguo/antique brass	1/25

Código Code	Acabado Finish	
991.700	negro mate/matt black	1/25
991.703	oro cepillado/brushed gold	1/25
991.706V	peltre/pewter	1/25
991.709	latón antiguo/antique brass	1/25

BELLA

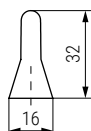
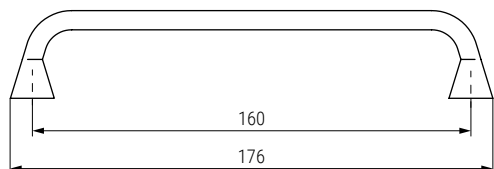
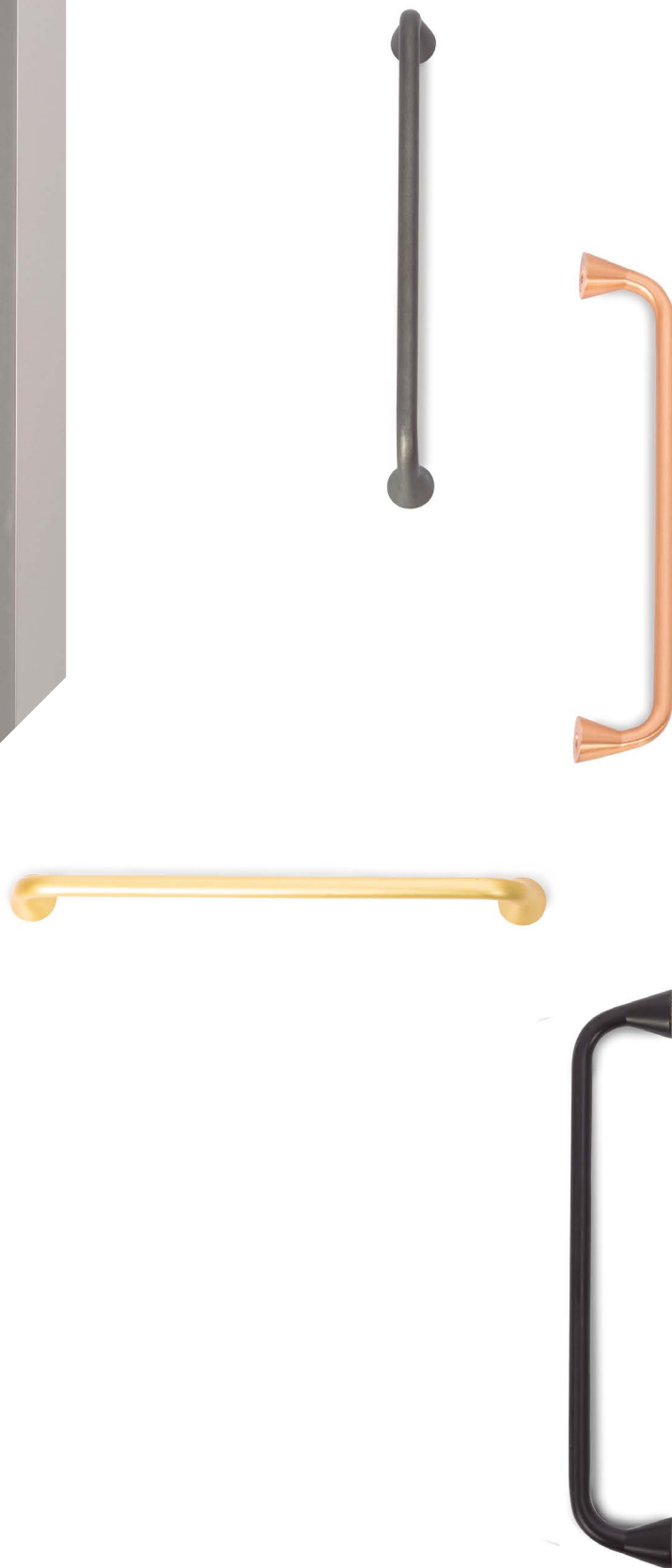
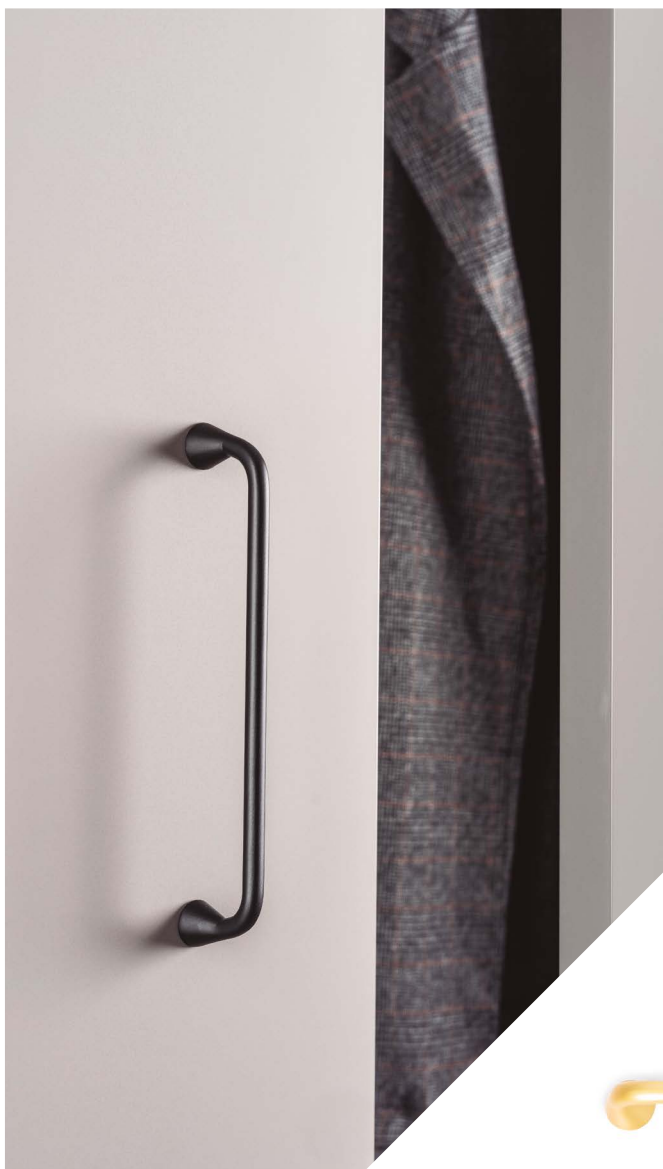

Código Code	Acabado Finish	
991.646	cobre cepillado/brushed copper	1/25
991.647	oro cepillado/brushed gold	1/25
991.648	gris grafito/graphite grey	1/25
991.649	negro mate/matt black	1/25

ESTE



Código
Code

Acabado
Finish



991.448	níquel cepillado/brushed nickle	1/25
991.449	negro mate/matt black	1/25
991.450	grafito/graphite	1/25
991.451	oro cepillado/brushed gold	1/25
991.452	cobre cepillado/brushed copper	1/25
991.1233	cromo brillo/polished chrome	1/25

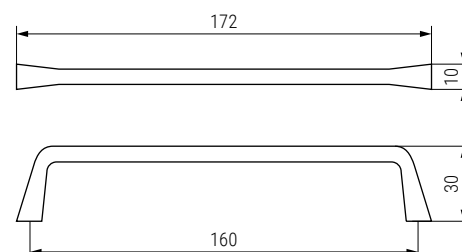

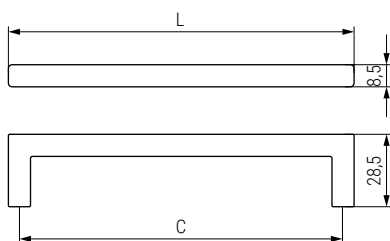

Código Code	C	L	Acabado Finish	
991.252	128	136,5	cromo/chrome	1/25
991.251	128	136,5	negro mate/matt black	1/25
991.253	128	136,5	cobre cepillado/brushed copper	1/25
991.254	128	136,5	latón cepillado/brushed brass	1/25
991.255	128	136,5	níquel cepillado/brushed nickel	1/25
991.796	128	136,5	blanco mate/matt white	1/25
991.797V	160	168,5	blanco mate/matt white	1/25
991.257	192	200,5	cromo/chrome	1/25
991.256	192	200,5	negro mate/matt black	1/25
991.258	192	200,5	cobre cepillado/brushed copper	1/25
991.259	192	200,5	latón cepillado/brushed brass	1/25
991.260	192	200,5	níquel cepillado/brushed nickel	1/25
991.798	192	200,5	blanco mate/matt white	1/25
991.262V	320	328,5	cromo/chrome	1/25
991.261	320	328,5	negro mate/matt black	1/25
991.263	320	328,5	cobre cepillado/brushed copper	1/25
991.264	320	328,5	latón cepillado/brushed brass	1/25
991.265	320	328,5	níquel cepillado/brushed nickel	1/25
991.799	320	328,5	blanco mate/matt white	1/25
991.267V	492	500,5	cromo/chrome	1/25
991.266	492	500,5	negro mate/matt black	1/25
991.268	492	500,5	cobre cepillado/brushed copper	1/25
991.269	492	500,5	latón cepillado/brushed brass	1/25
991.270	492	500,5	níquel cepillado/brushed nickel	1/25
991.800	492	500,5	blanco mate/matt white	1/25



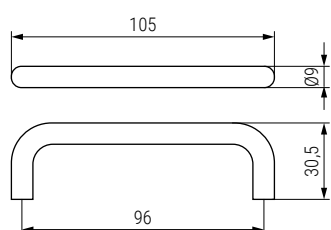

Código
Code

Acabado
Finish



9035.1056	aluminio RAL9006/aluminium RAL9006	1/75
9035.1059	negro mate/matt black	1/75
9035.1072	blanco mate/matt white	1/75

PURA

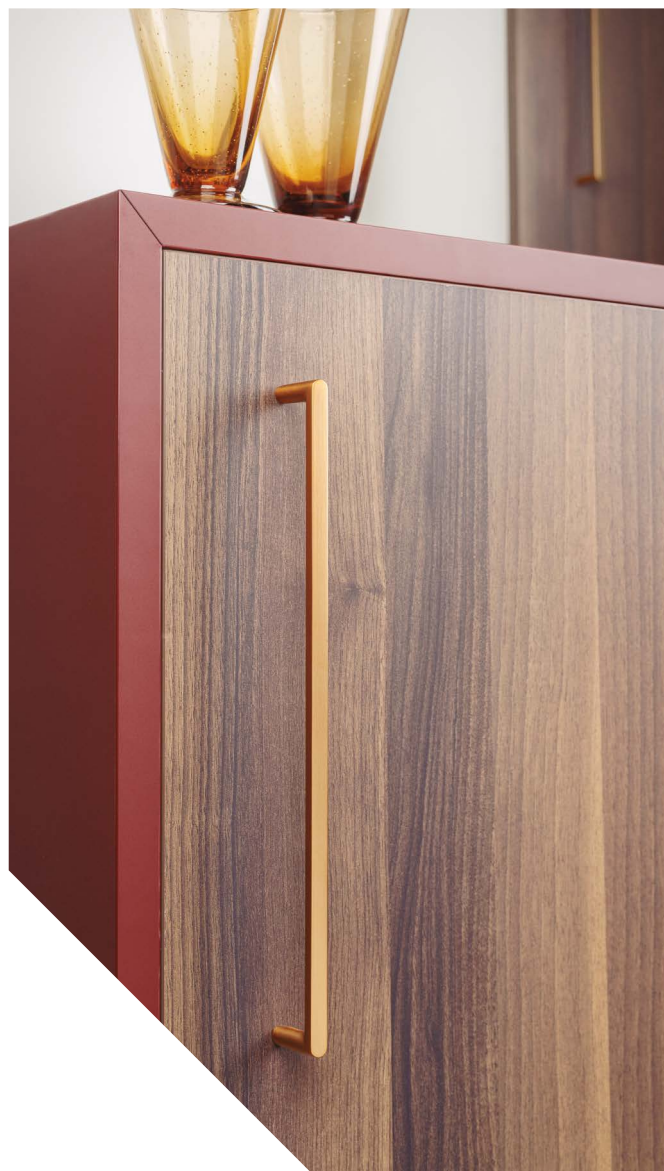
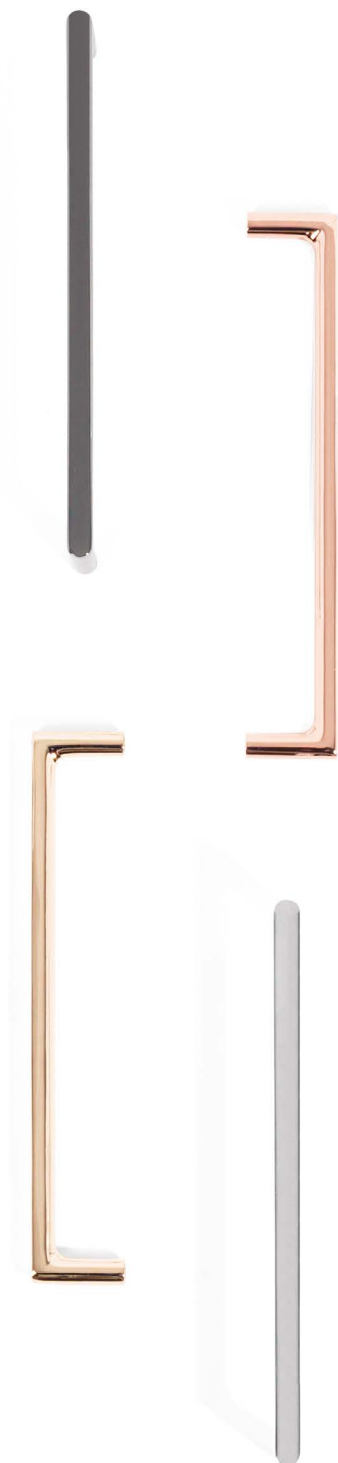

Código Code	Acabado Finish	
991.453	cromo/chrome	1/25
991.454	negro brillo/brushed black	1/25
991.455	cobre brillo/brushed copper	1/25
991.456	latón brillo/brushed brass	1/25

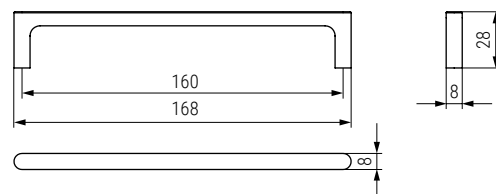

VALLEY

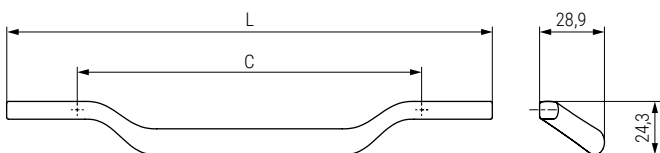
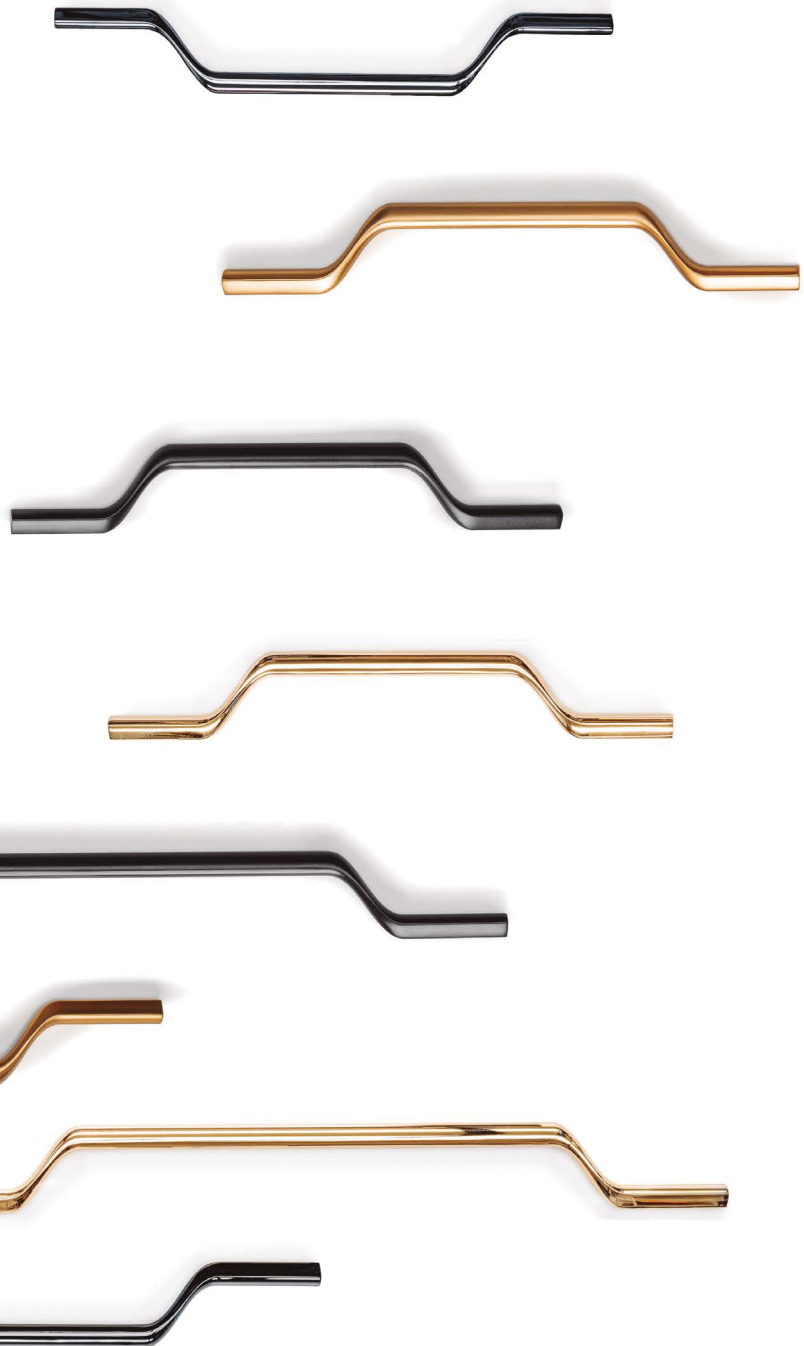

Código Code	C	L	Acabado Finish	
991.911	160	223	níquel negro/black nickel	1/25
991.913	160	223	latón brillo/polished brass	1/25
991.915	160	223	latón cava/cava brass	1/25
991.917	160	223	negro mate /matt black	1/25
991.912	256	330	níquel negro/black nickel	1/25
991.914	256	330	latón brillo/polished brass	1/25
991.916	256	330	latón cava/cava brass	1/25
991.918	256	330	negro mate /matt black	1/25



ORANGENO

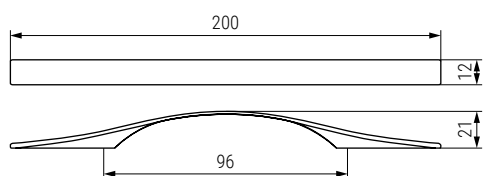

Código Code	Acabado Finish	
1435.596	aluminio RAL9006/aluminium RAL9006	1/50
1435.597	negro mate/matt black	1/50
1435.598	latón satinado/satin brass	1/50

MACA



Código
Code

Acabado
Finish



544.576	antica firenze/antique brass	1/25
544.575	negro mate/matt black	1/25

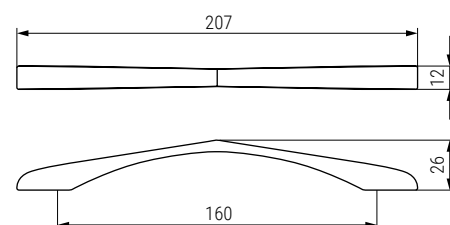

MARITA

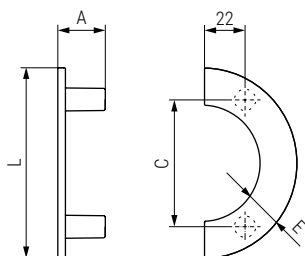
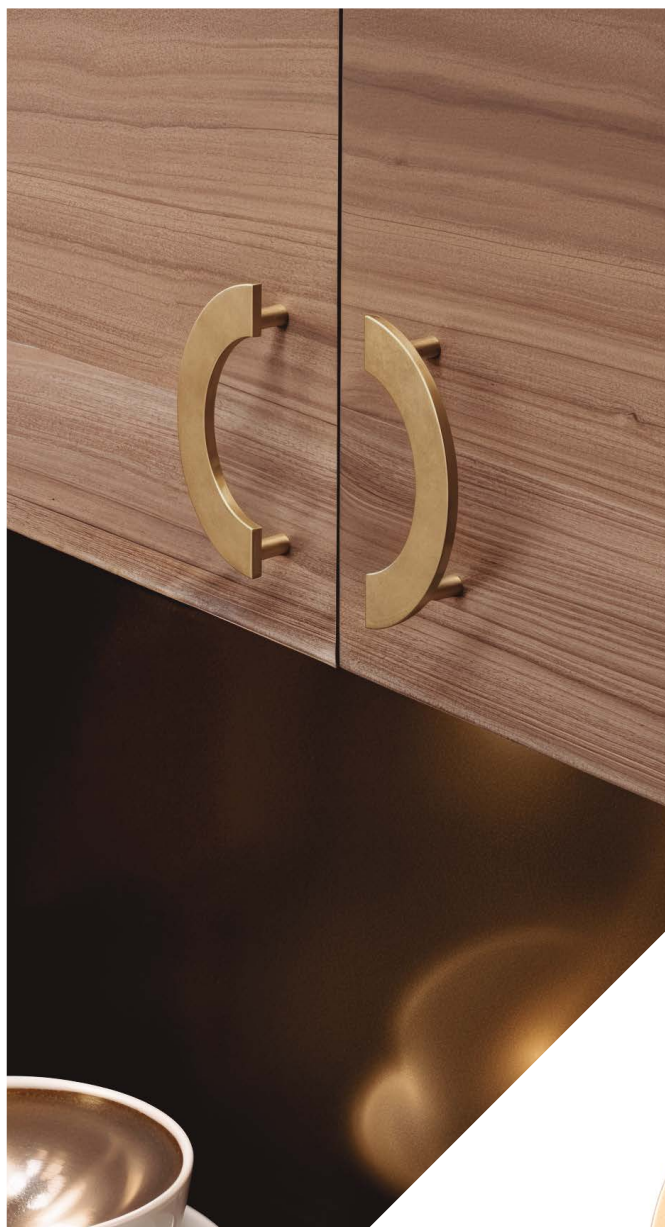

Código Code	L	C	E	A	Acabado Finish	
544.792	102	68	20	25	oro satinado/satin gold	1/20
544.791	164	132	25	26	oro satinado/satin gold	1/10

BASARTO

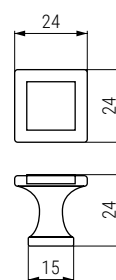
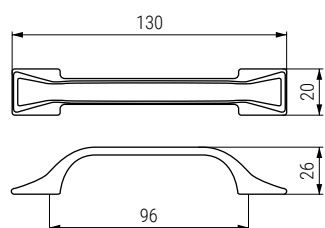

Código
Code

544.22

Acabado
Finish

antica firenze/antique brass



1/50

Código
Code

544.21

Acabado
Finish

antica firenze/antique brass



1/50

KOLO

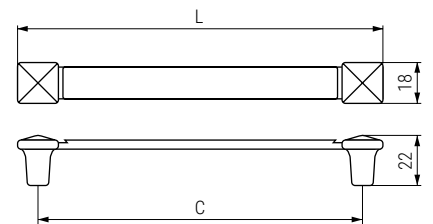
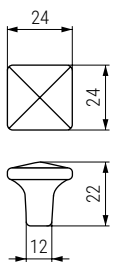

Código Code	Acabado Finish	
544.24	antica firenze/antique brass	1/50

Código Code	C	L	Acabado Finish	
544.44	96	114	antica firenze/antique brass	1/50
544.45	128	146	antica firenze/antique brass	1/25
544.46	192	210	antica firenze/antique brass	1/25



TYRA

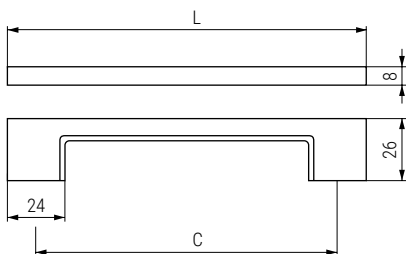

Código Code	C	L	Acabado Finish	
1435.518	128	154	aluminio RAL9006/aluminium RAL9006	1/50
1435.511	128	154	negro mate/matt black	1/50
1435.527	128	154	blanco mate/matt white	1/50
1435.508	128	154	latón satinado/satin brass	1/50
1435.520	160	192	aluminio RAL9006/aluminium RAL9006	1/50
1435.512	160	192	negro mate/matt black	1/50
1435.528	160	192	blanco mate/matt white	1/50
1435.509	160	192	latón satinado/satin brass	1/50
1435.522	256	292	aluminio RAL9006/aluminium RAL9006	1/50
1435.513	256	292	negro mate/matt black	1/50
1435.529	256	292	blanco mate/matt white	1/50
1435.510	256	292	latón satinado/satin brass	1/50

NAME



Código Code	Acabado Finish	
1435.575	aluminio RAL9006/aluminium RAL9006	1/100
1435.577	blanco mate/matt white	1/50
1435.576	negro mate/matt black	1/100
1435.578 ^V	marrón R8019/brown R8019	1/100
1435.579	latón satinado/satin brass	1/100

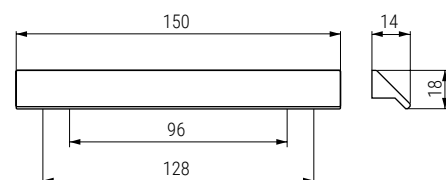



TABLA



Código Code	L	C	Acabado Finish	
544.2	140	128	aluminio RAL9006/aluminium RAL9006	1/25
544.901	140	128	negro mate/matt black	1/25
544.1	235	224	aluminio RAL9006/aluminium RAL9006	1/25
544.902	235	224	negro mate/matt black	1/25







CORVO

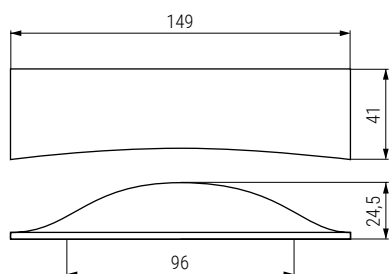

Código
Code

Acabado
Finish



1435.538
1435.639

aluminio RAL9006/aluminium RAL9006
negro mate/matt black

1/35
1/50



GRAMOLA

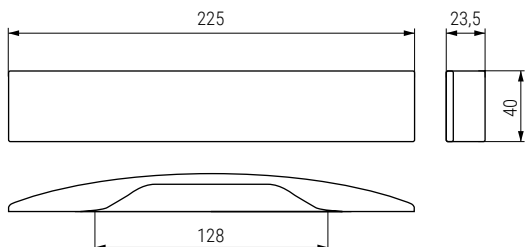

- Con tuerca de hierro embutida, M6.
- Especial para canapés de gran peso.
- With embedded iron nut, M6
- Specially designed for heavy-duty storage beds.

Código Code	Material	Acabado Finish	
135.101	haya/beech	wengue/wenge	1/210
135.102	haya/beech	cerezo/cherry	1/210
135.104	haya/beech	natural/natural	1/140
135.105	haya/beech	sin pintar/unpainted	1/210

CARLO

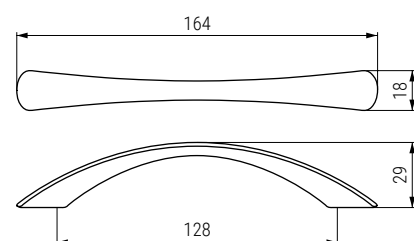

Código
Code

1435.21

Acabado
Finish

aluminio RAL9006/aluminium RAL9006



1/50



COLMENA

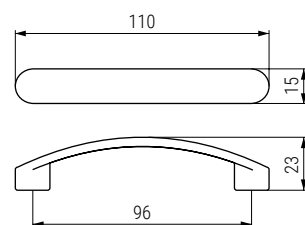

Código Code	Acabado Finish	
9035.1080	aluminio RAL9006/aluminium RAL9006	1/75
9035.1081	negro mate/matt black	1/75



ORANGE



Código Code	Acabado Finish	
1435.553	cromo/chromo	1/30
1435.554	aluminio RAL9006/aluminium RAL9006	1/30
1435.555	negro mate/matt black	1/30

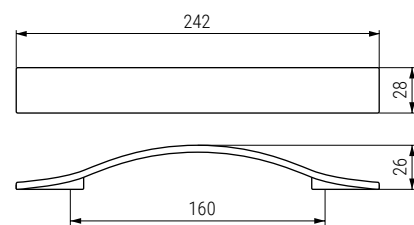





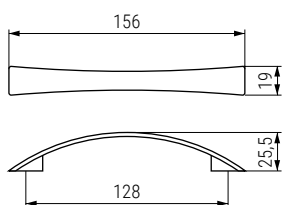

Código
Code

Acabado
Finish



1435.638
1435.639

aluminio RAL9006/aluminium RAL9006
negro mate/matt black

1/60
1/50

ACON

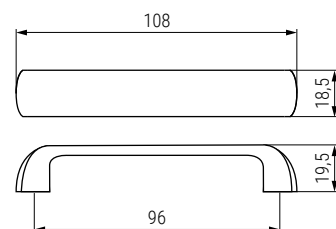

Código Code	Acabado Finish	
9035.1131	aluminio RAL9006/aluminium RAL9006	1/90
9035.1132	negro mate/matt black	1/90





ANDYNO

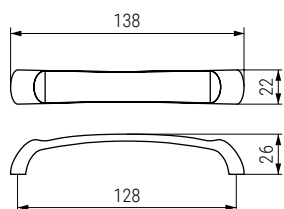

Código
Code

Acabado
Finish



1435.685
1435.686

aluminio RAL9006/aluminium RAL9006
negro mate/matt black

1/50
1/50

EVAN



Código Code	C	L	Acabado Finish	
1435.376	96	106	latón satinado/satin brass	1/50
1435.402	96	106	aluminio RAL9006/aluminium RAL9006	1/50
1435.382	96	106	blanco mate /matt white	1/50
1435.392	96	106	negro mate /matt black	1/50
1435.377	128	138	latón satinado/satin brass	1/50
1435.403	128	138	aluminio RAL9006/aluminium RAL9006	1/50
1435.383	128	138	blanco mate /matt white	1/50
1435.393	128	138	negro mate /matt black	1/50
1435.378	224	235	latón cepillado/brushed brass	1/40
1435.404	224	235	aluminio RAL9006/aluminium RAL9006	1/40
1435.384	224	235	blanco mate /matt white	1/40
1435.394	224	235	negro mate /matt black	1/40
1435.379	320	328	latón cepillado/brushed brass	1/40
1435.405	320	328	aluminio RAL9006/aluminium RAL9006	1/40
1435.385	320	328	blanco mate /matt white	1/40
1435.395	320	328	negro mate /matt black	1/40

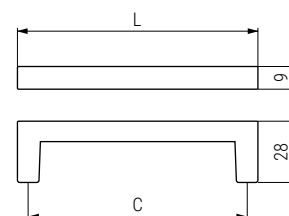





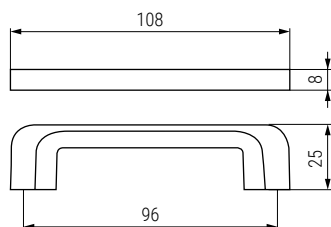

Código
Code

Acabado
Finish



9035.544
9035.545

aluminio RAL9006/aluminium RAL9006
negro mate/matt black

1/50
1/50

OLANO



Código Code	Acabado Finish	
9035.425	aluminio RAL9006/aluminium RAL9006	1/100
9035.426	negro mate/matt black	1/100
9035.427	blanco/white	1/100

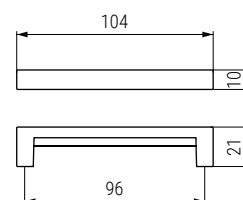





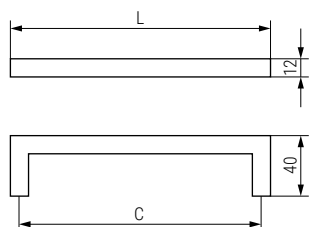
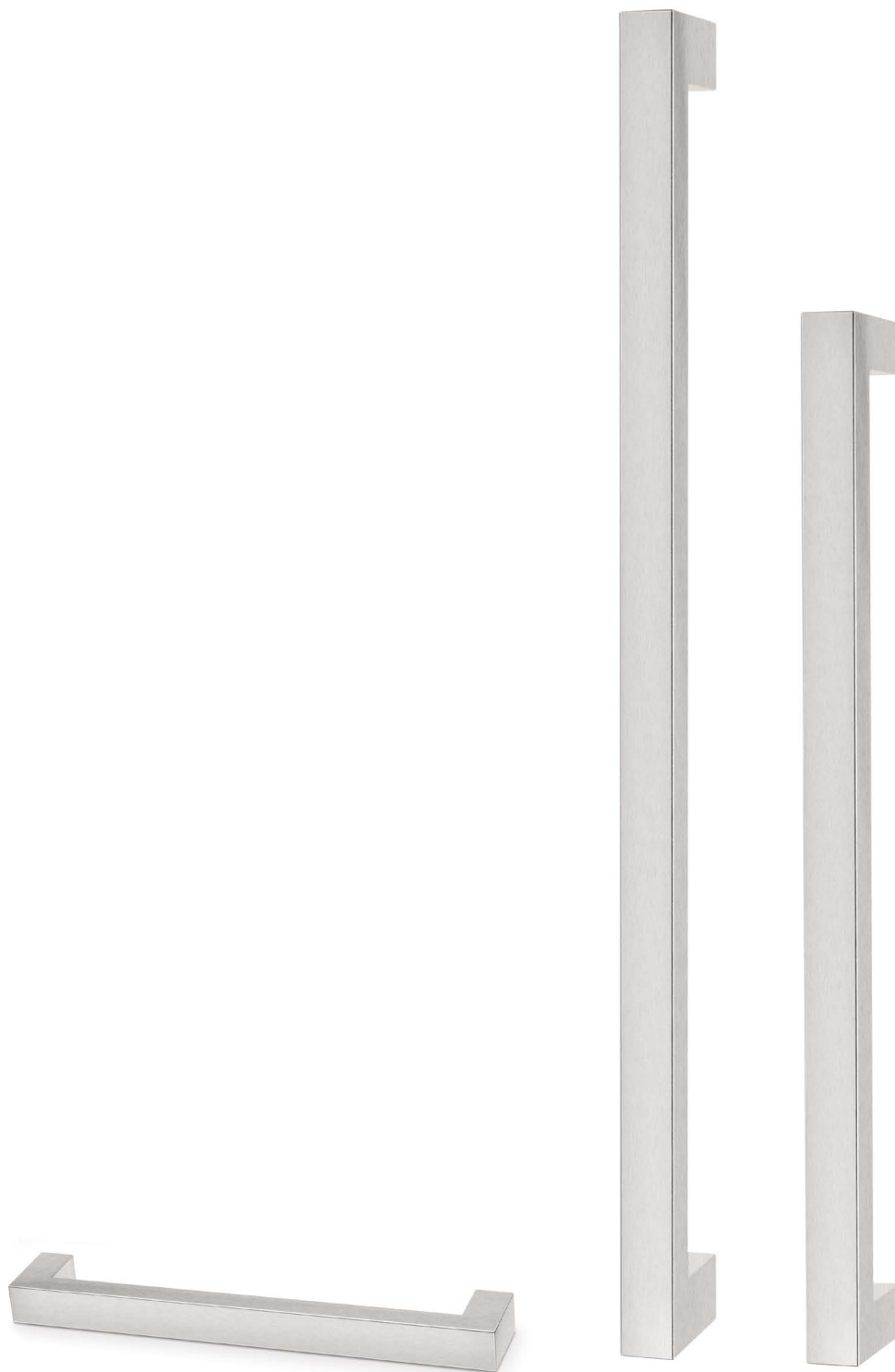

KUBE



Código Code	C	L	Acabado Finish	
9041.13	160	170	inox mate/matt stainless steel	1/25
9041.14	192	204	inox mate/matt stainless steel	1/25
9041.15	320	332	inox mate/matt stainless steel	1/25
9041.16	512	524	inox mate/matt stainless steel	1/25

PIREO



Código Code	C	L	Acabado Finish	
9039.1	96	156	inox mate/matt stainless steel	1/50
9039.11	96	160	negro mate/matt black	1/25
9039.2	128	188	inox mate/matt stainless steel	1/50
9039.12	128	190	negro mate/matt blackl	1/25
9039.13	160	222	negro mate/matt black	1/25
9039.3	192	252	inox mate/matt stainless steel	1/50
9039.14	192	254	negro mate/matt black	1/10
9039.4	256	336	inox mate/matt stainless steel	1/50
9039.5	320	400	inox mate/matt stainless steel	1/25
9039.6	384	464	inox mate/matt stainless steel	1/50
9039.7	448	528	inox mate/matt stainless steel	1/50

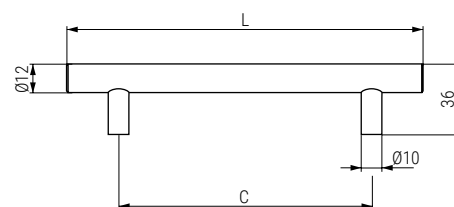



ZEBRA

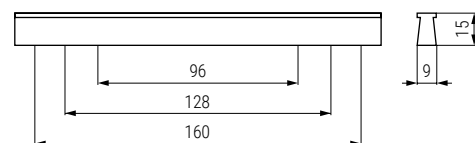
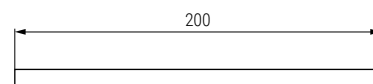

- Para colocar con tornillos rosca madera.
- For installation with wood screws.

Código Code	Acabado Finish	
597.4	aluminio RAL9006/aluminium RAL9006	1/25

TRAMA

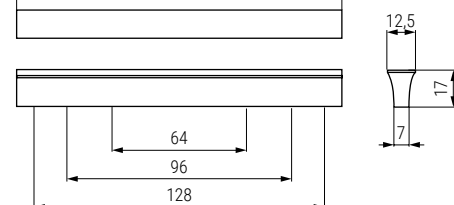
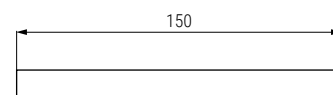
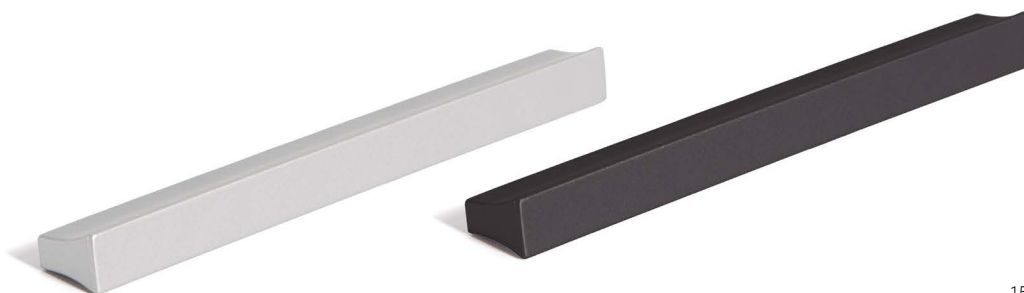

- Para colocar con tornillos rosca madera.
- For installation with wood screws.

Código Code	Acabado Finish	
597.3	aluminio RAL9006/aluminium RAL9006	1/25
597.23	negro mate/matt black	1/25

MAIOLA

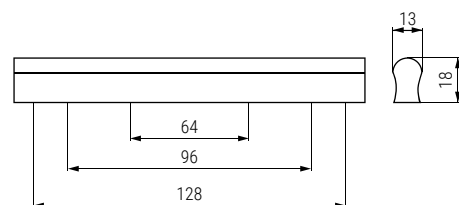
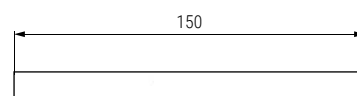



- Para colocar con tornillos rosca madera.
- For installation with wood screws.

Código Code	Acabado Finish	
597.2	aluminio RAL9006/aluminium RAL9006	1/25
597.22	negro mate/matt black	1/25



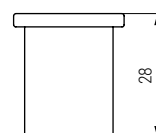
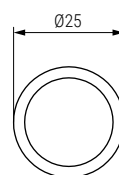

ROUND

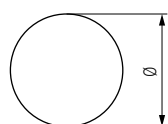
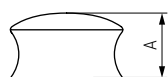

Código Code	Acabado Finish	
991.27	latón cepillado/brushed brass	1/25
991.28	negro cepillado/brushed black	1/25
991.29	inox look/matt stainless steel	1/25

PRESCOTT



Código Code	Ø	L	Acabado Finish	
544.803	30	22	oro satinado/satin gold	1/25
544.808	30	22	negro mate/matt black	1/25
544.802	40	23	oro satinado/satin gold	1/25
544.807	40	23	negro mate/matt black	1/25
544.801	50	24	oro satinado/satin gold	1/25
544.806	50	24	negro mate/matt black	1/25



LUNA

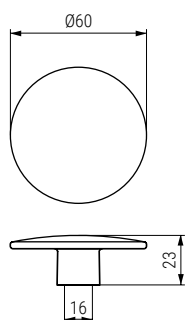

Código
Code

Acabado
Finish



1435.494
1435.495

aluminio RAL9006/aluminium RAL9006
negro mate/matt black

1/50
1/50

DUKE

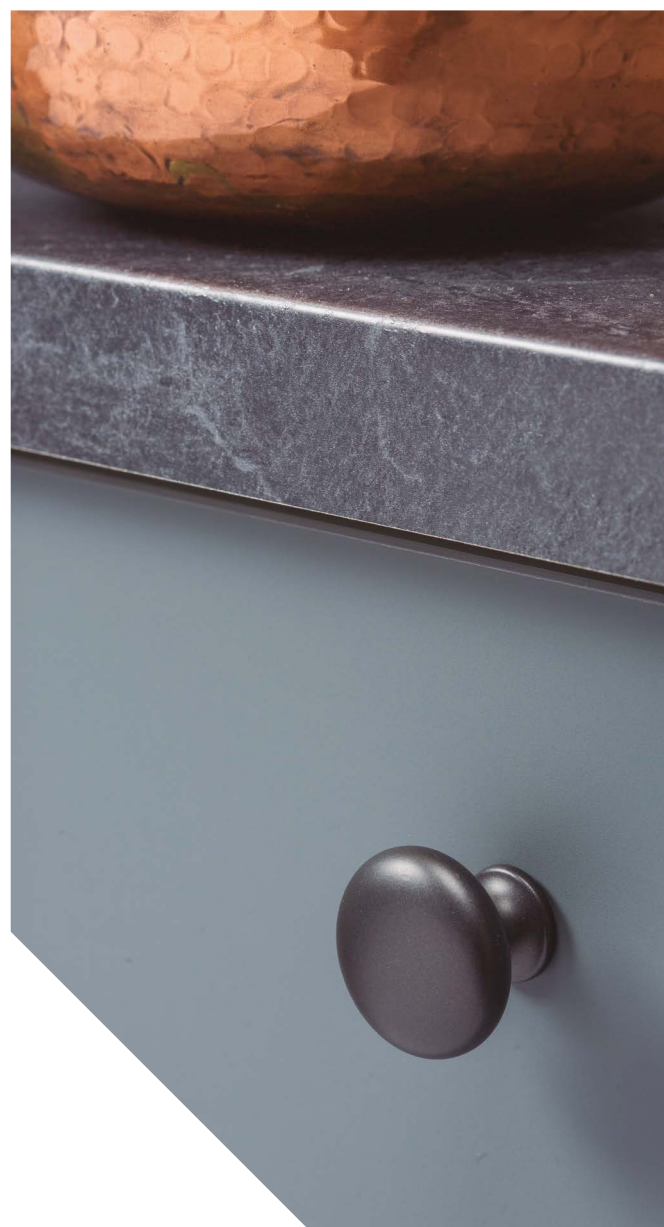

Código
Code

Acabado
Finish



991.902	níquel cepillado/brushed nickel	1/25
991.903V	cobre cepillado/brushed copper	1/25
991.904	latón cepillado mate/matt brushed brass	1/25
991.905V	peltre/pewter	1/25
991.906V	plata antigua/antique silver	1/25
991.907V	latón antiguo/antique brass	1/25
991.908V	cobre antiguo/antique copper	1/25
991.909V	blanco mate/matt white	1/25
991.910	negro mate/matt black	1/25

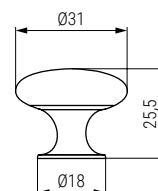

COMO

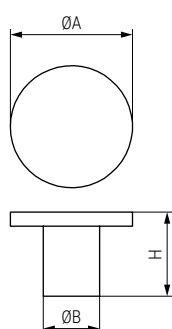

Código Code	ØA	ØB	H	Acabado Finish	
991.513V	26	12	18	cromo/chrome	1/25
991.514	26	12	18	cromo mate/matt chrome	1/25
991.515	26	12	18	níquel cepillado/brushed nickel	1/25
991.516	26	12	18	cobre cepillado/brushed copper	1/25
991.517	26	12	18	oro cepillado/brushed gold	1/25
991.518	26	12	18	blanco mate/matt white	1/25
991.519	26	12	18	negro mate/matt black	1/25
991.520V	41	13	25	cromo/chrome	1/25
991.521	41	13	25	cromo mate/matt chrome	1/25
991.522	41	13	25	níquel cepillado/brushed nickel	1/25
991.523	41	13	25	cobre cepillado/brushed copper	1/25
991.524	41	13	25	oro cepillado/brushed gold	1/25
991.525	41	13	25	blanco mate/matt white	1/25
991.526	41	13	25	negro mate/matt black	1/25



PARMA

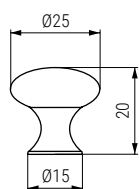

Código
Code

Acabado
Finish



9035.2	cromo/chromo	1/200
9035.3	cromo mate/matchromo	1/200
9035.4	negro mate/matt black	1/200
9035.5	laton satinado/satin brass	1/200
9035.6	oro viejo/old gold	1/200
9035.7	niquel mate/matt nickel	1/200
9035.17	blanco mate/matt white	1/200



GUSTA

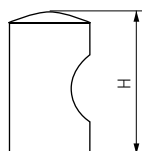
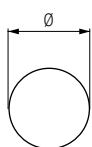
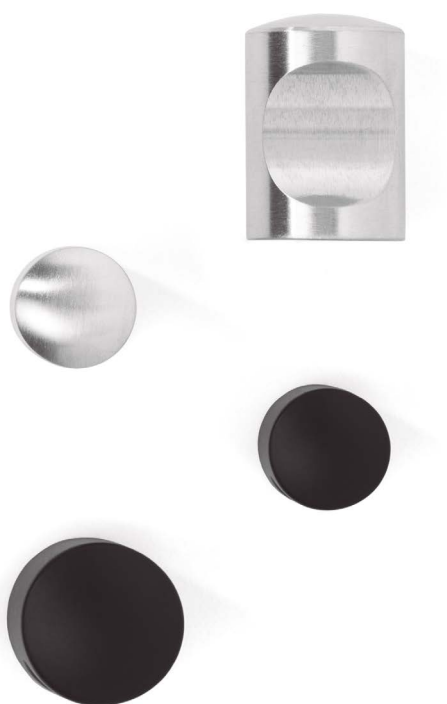

Código Code	Ø	H	Acabado Finish	
9041.11	15	26	inox mate/matt stainless steel	1/25
9041.41	15	26	negro mate/matt black	1/20
9041.12	20	28	inox mate/matt stainless steel	1/25
9041.42	20	28	negro mate/matt black	1/20



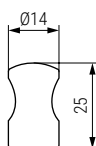

PISA



Código Code	Acabado Finish	
9035.23	chromo mate/matt chromo	1/100
9035.24	blanco mate/matt white	1/100
9035.25	negro mate/matt black	1/100
9035.26	níquel mate/matt nickel	1/100

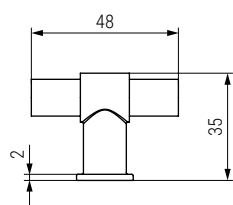
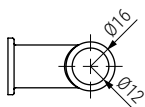
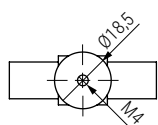



Código Code	Acabado Finish	
700.191	negro mate/matt black	1/10
700.192	latón mate/matt brushed	1/10
700.193	níquel mate/matt nickel	1/10

EQUIS

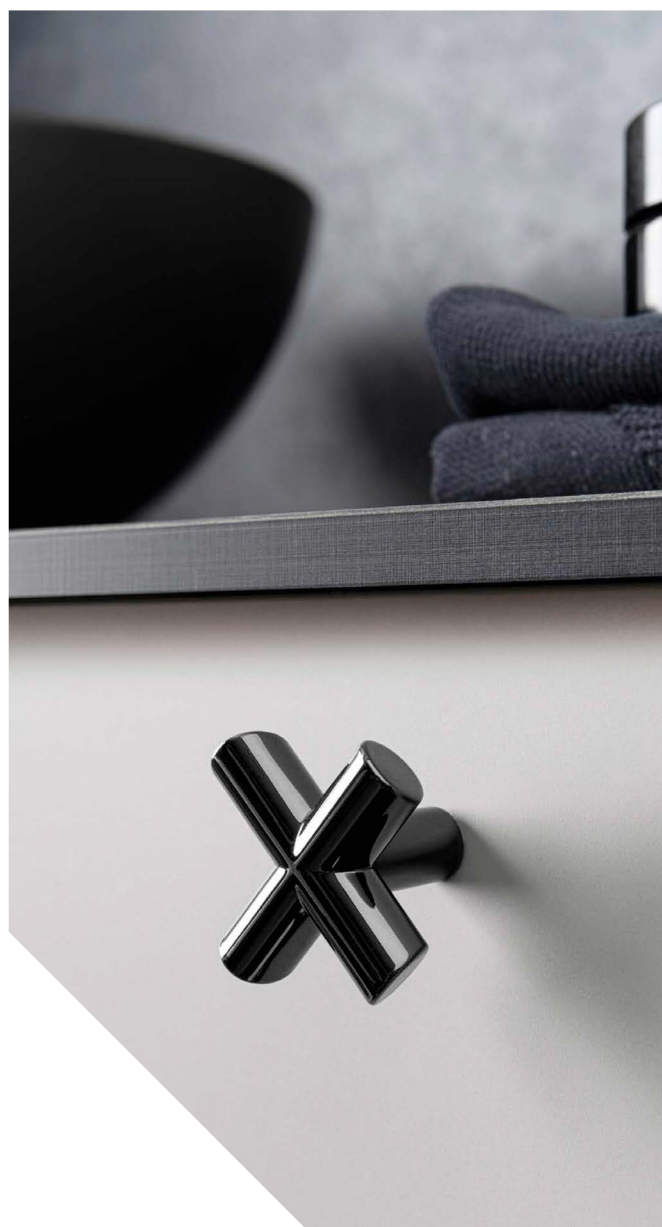

Código Code	Acabado Finish	 1/25
991.1000	cromo/chromo	1/25
991.1001	negro brillo/polished black	1/25
991.1002	cobre brillo/polished copper	1/25
991.1003	latón brillo/polished brass	1/25
991.1004	blanco mate/matt white	1/25
991.1005	negro mate/matt black	1/25

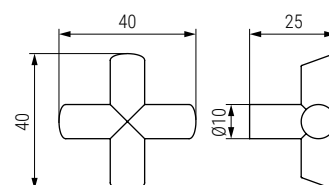

PRIMS

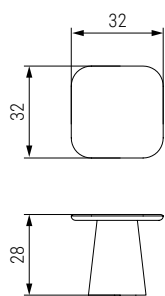

Código Code	Acabado Finish	
991.1032	blanco mate/matt white	1/25
991.1033	negro mate/matt black	1/25
991.1080	negro titanio brillo/polished titanium black	1/25
991.1081	negro brillo/polished black	1/25
991.1082	níquel brillo/polished nickel	1/25
991.1083	latón brillo/polished brass	1/25
991.168	latón cava cepillado/brushed champagne brass	1/25

CAPO

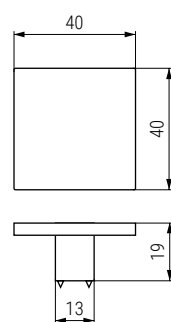

Código Code	Acabado Finish	
1435.560	aluminio RAL9006/aluminium RAL9006	1/100
1435.561	negro mate/matt black	1/100



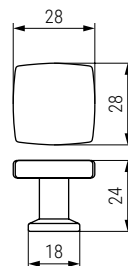

CHIKE

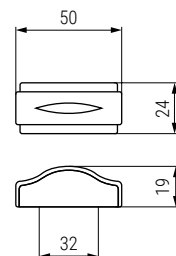

Código Code	Acabado Finish	
544.703	negro mate/matt black	1/50
544.706	marron/brown	1/50

CAURIUM



Código Code	Acabado Finish	
544.72	antica firenze/antique brass	1/50

HEIDI

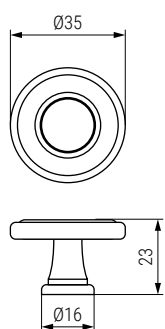

Código Code	Acabado Finish	
544.684	antica firenze/antique brass	1/50
544.690	plata vieja/antique silver	1/50

CLOVIS

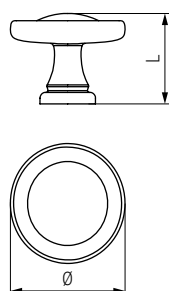

Código Code	Ø	L	Acabado Finish	
544.775	35	24	oro satinado/satin gold	1/50
544.778	35	24	bronce/bronze	1/50

FLEXA



Código Code	Acabado Finish	
991.380	beige-cromo/beige-chrome	1/25
991.381	marrón-cromo/brown-chrome	1/25
991.382	negro-cromo/black-chrome	1/25
991.383	beige-negro/beige-black	1/25
991.384	marrón-negro/brown-black	1/25
991.385	negro-negro/black-black	1/25

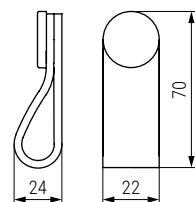



BAMBÚ

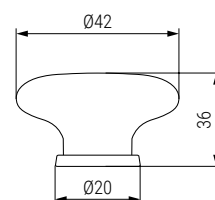
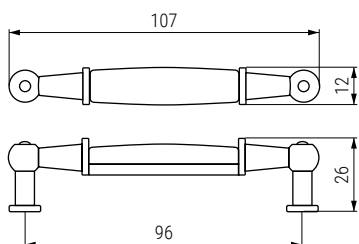
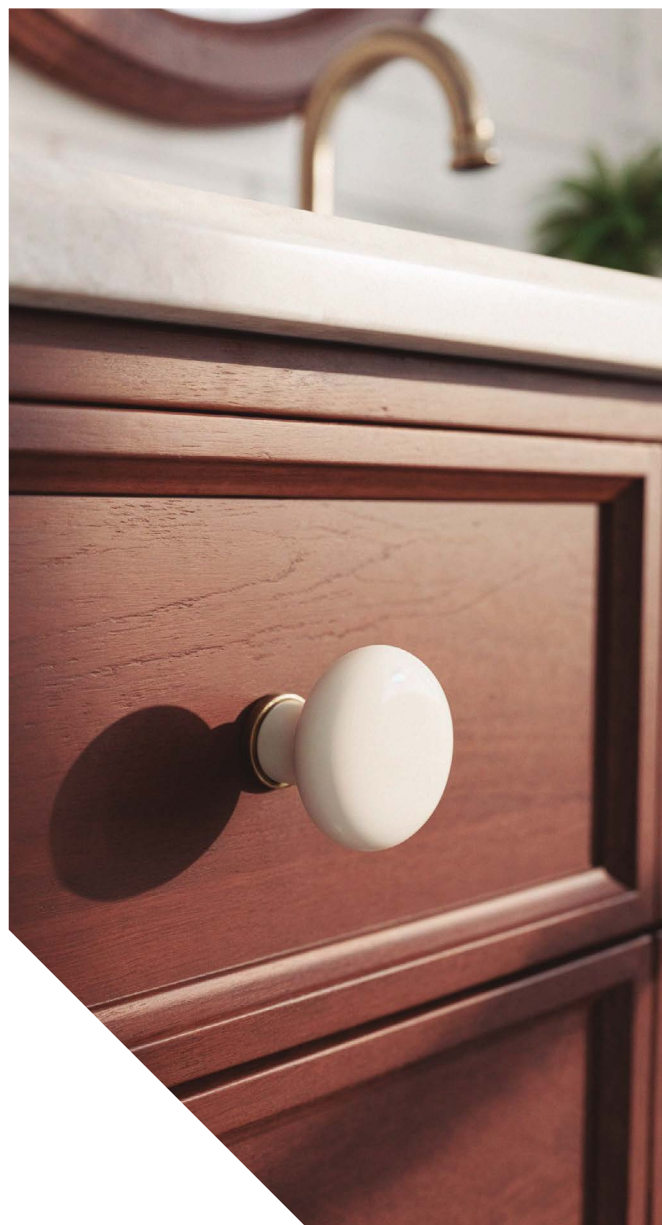

Código
Code

1002.23

Acabado
Finish

marfil-bronce/ivory bronze



1/25

Código
Code

1002.40

Acabado
Finish

marfil-bronce/ivory bronze



1/25

TRILLA

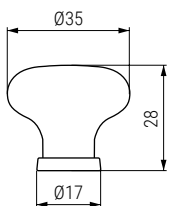

Código
Code

1002.12

Acabado
Finish

gres marrón-bronce/ stoneware brown-bronze



1/50

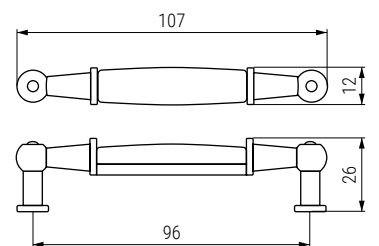

Código
Code

1002.14

Acabado
Finish

gres marrón-bronce/ stoneware brown-bronze



1/25

TIZAM



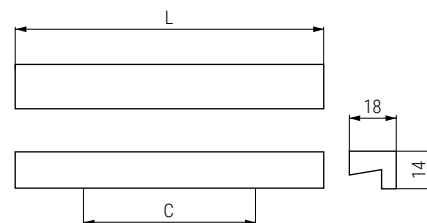

Código Code	C	L	Acabado Finish	
9035.1088	64	84,5	aluminio RAL9006/aluminium RAL9006	1/75
9035.1086	64	84,5	blanco mate/matt white	1/75
9035.1087	64	84,5	negro mate/matt black	1/75
9035.1089	64/128	158	aluminio RAL9006/aluminium RAL9006	1/75
9035.1090	64/128	158	blanco mate/matt white	1/75
9035.1091	64/128	158	negro mate/matt black	1/75





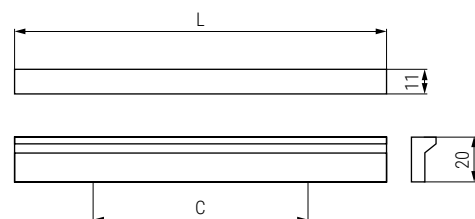

ANGLE



Código Code	C	L	
Anodizado mate Matte anodized			
991.581	32	45	1/25
991.582	64	90	1/25
991.583	96	120	1/25
991.584	128	150	1/25
991.585	160	190	1/25
991.586	192	250	1/25
991.587	256	300	1/25

Código Code	C	L		
Cromo Polished chrome				
Latón ant. cepillado Brushed dark brass				
991.98	991.592	64	100	1/25
991.103	991.593	96/128/160	200	1/25
991.104	991.594	192	300	1/25
991.105	991.595	256/320	400	1/25
991.106V	991.596	320/416	500	1/25
991.107	991.597	480/512	600	1/25
991.108	991.598	640	900	1/25

Código Code	C	L		
Blanco mate Matt white				
Negro mate Matt black				
991.162	991.532	64	100	1/25
991.163	991.533	128/160	200	1/25
991.164	991.534	192	300	1/25
991.165	991.535	256	400	1/25
991.166	991.536	416	500	1/25
991.167	991.537	480	600	1/25
991.168	991.538	640	900	1/25
991.169	991.539	480/1440	1480	1/10





KIONA

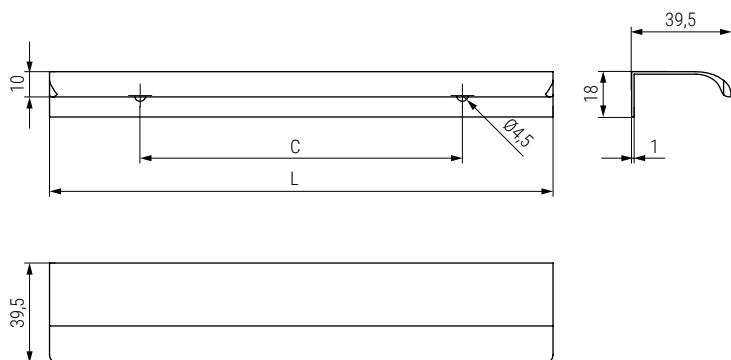

Código Code	C	L	Acabado Finish	
9042.121	64	100	plata mate/matt silver	50/500
9042.122	64	100	negro mate/matt black	50/500
9042.127	64	100	blanco mate/matt black	50/200
9042.123	128	200	plata mate/matt silver	25/250
9042.124	128	200	negro mate/matt black	25/250
9042.128	128	200	blanco mate/matt black	25/200
9042.125	192	300	plata mate/matt silver	20/200
9042.126	192	300	negro mate/matt black	20/200
9042.129	192	300	blanco mate/matt black	20/200

KORBI

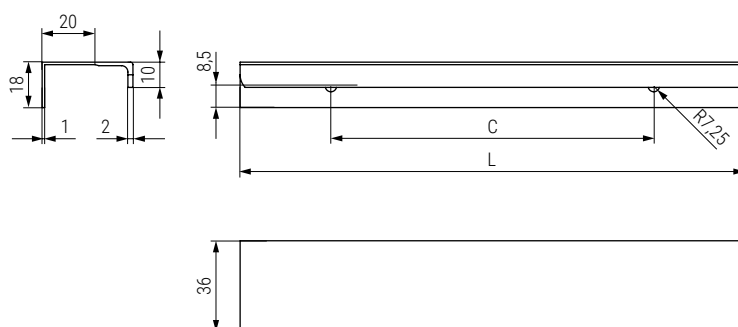

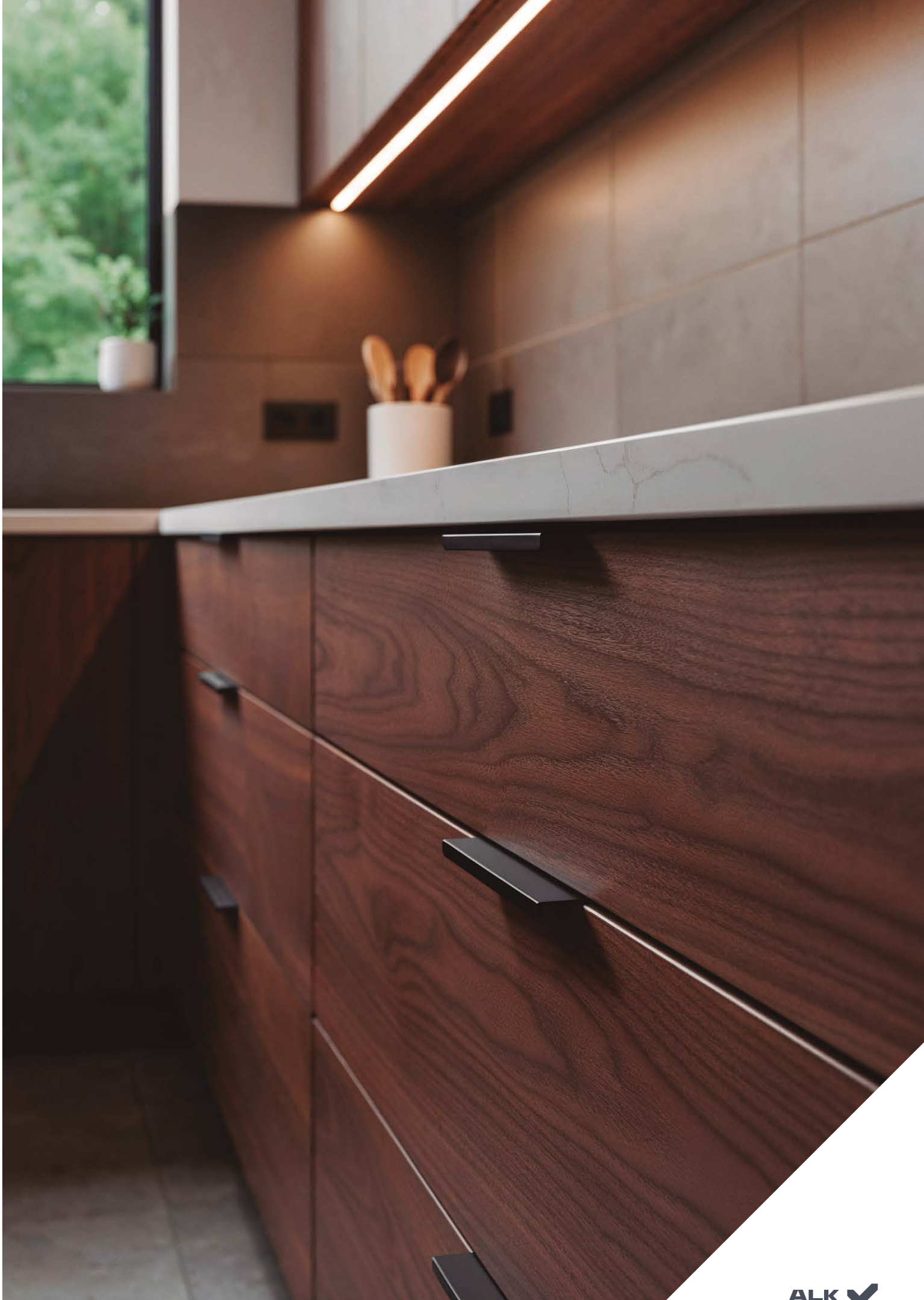

Código Code	C	L	Acabado Finish	
9042.111	64	100	plata mate/matt silver	100/1.000
9042.112	64	100	negro mate/matt black	100/1.000
9042.113	128	200	plata mate/matt silver	50/500
9042.114	128	200	negro mate/matt black	50/500
9042.115	192	300	plata mate/matt silver	25/250
9042.116	192	300	negro mate/matt black	25/250



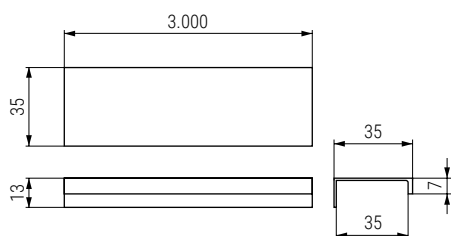

PETIAL



Código Code	Largo Long	Acabado Finish	
398.8	3,05m.	plata mate/matt silver	1/16
398.18	3,05m.	negro mate/matt black	1/16
398.19	3,05m.	blanco mate/matt white	1/16



VANN

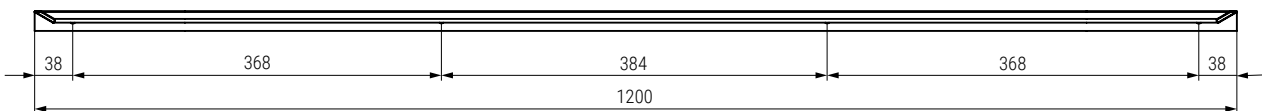
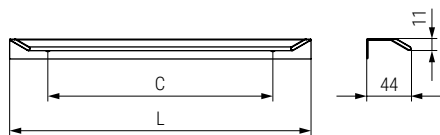
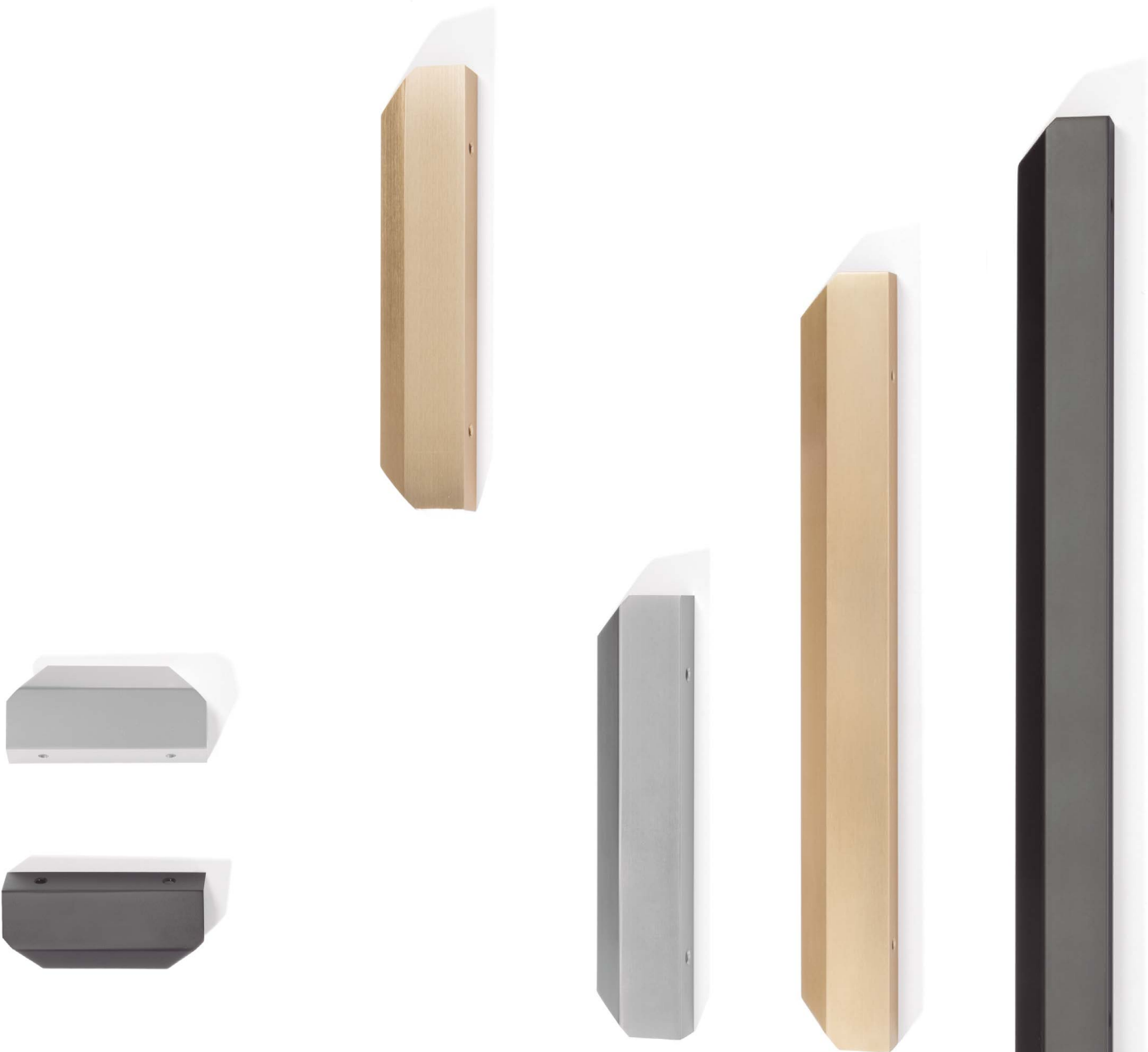

Código Code	L	L	Acabado Finish	
991.322	100	100	negro mate/matt black	1/25
991.330	100	100	latón oscuro cepillado/brushed dark brass	1/25
991.323	200	200	negro mate/matt black	1/25
991.331	200	200	latón oscuro cepillado/brushed dark brass	1/25
991.324	350	350	negro mate/matt black	1/25
991.332	350	350	latón oscuro cepillado/brushed dark brass	1/25
991.325	1200	1200	negro mate/matt black	1/15
991.333	1200	1200	latón oscuro cepillado/brushed dark brass	1/15



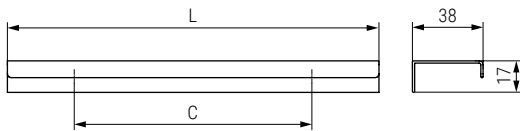

Código Code	C	L	Acabado Finish	
991.721	32	50	anodizado mate/ matt anodised	1/25
991.727	32	50	latón oscuro cepillado/ brushed dark brass	1/25
991.733	32	50	negro mate/matt black	1/25
991.715V	32	50	blanco mate/matt white	1/25
991.722	64	100	anodizado mate/ matt anodised	1/25
991.728	64	100	latón oscuro cepillado/ brushed dark brass	1/25
991.734	64	100	negro mate/matt black	1/25
991.716	64	100	blanco mate/matt white	1/25
991.723	128	200	anodizado mate/ matt anodised	1/25
991.729	128	200	latón oscuro cepillado/ brushed dark brass	1/25
991.735	128	200	negro mate/matt black	1/25
991.717	128	200	blanco mate/matt white	1/25
991.724	320	400	anodizado mate/ matt anodised	1/25
991.730	320	400	latón oscuro cepillado/ brushed dark brass	1/25
991.736	320	400	negro mate/matt black	1/25
991.718	320	400	blanco mate/matt white	1/25

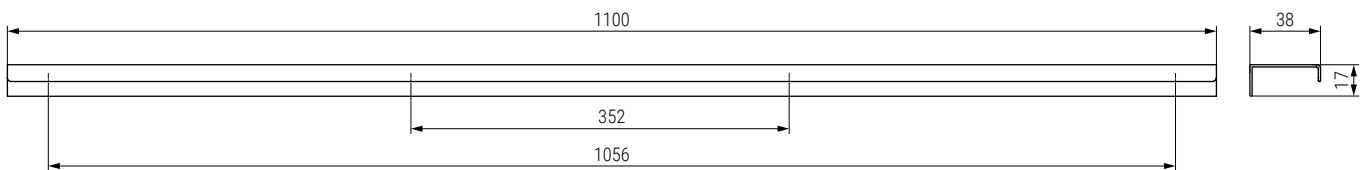
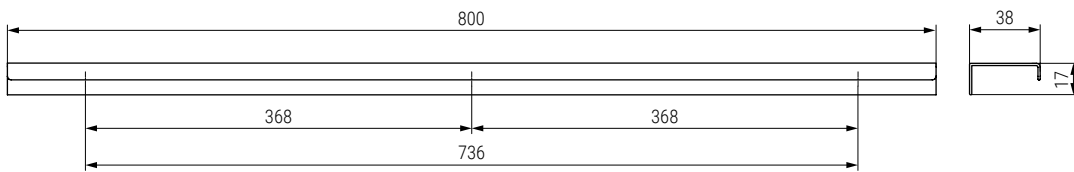

• Con mecanizado en el centro del tirador
 • With central machining on the handle

Código Code	C	L	Acabado Finish	
991.725V	736	800	anodizado mate/ matt anodised	1/25
991.731	736	800	latón oscuro cepillado/ brushed dark brass	1/25
991.737	736	800	negro mate/matt black	1/25
991.719V	736	800	blanco mate/matt white	1/25

Código Code	C	L	Acabado Finish	
991.726	354/1056	1100	anodizado mate/ matt anodised	1/15
991.732	354/1056	1100	latón oscuro cepillado/ brushed dark brass	1/15
991.738	354/1056	1100	negro mate/matt black	1/15
991.720	354/1056	1100	blanco mate/matt white	1/15

JEY

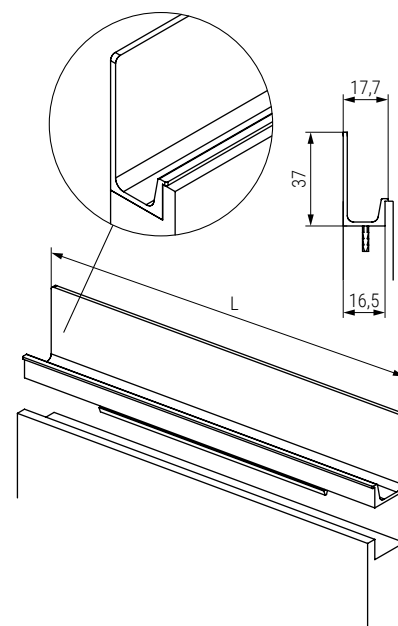

Código Code	L	Acabado Finish	
991.801V	147	blanco mate/matt white	1/15
991.802	197	blanco mate/matt white	1/15
991.803	247	blanco mate/matt white	1/15
991.804	297	blanco mate/matt white	1/15
991.805	347	blanco mate/matt white	1/15
991.806	397	blanco mate/matt white	1/15
991.807	447	blanco mate/matt white	1/10
991.808	497	blanco mate/matt white	1/10
991.809	597	blanco mate/matt white	1/10
991.810	697	blanco mate/matt white	1/10
991.811	797	blanco mate/matt white	1/10
991.812	897	blanco mate/matt white	1/5
991.813	997	blanco mate/matt white	1/5
991.814	1197	blanco mate/matt white	1/5
991.815	3.000	blanco mate/matt white	1/15

Código Code	L	Acabado Finish	
991.816	147	negro mate/matt black	1/15
991.817	197	negro mate/matt black	1/15
991.818	247	negro mate/matt black	1/15
991.819	297	negro mate/matt black	1/15
991.820	347	negro mate/matt black	1/15
991.821	397	negro mate/matt black	1/15
991.822	447	negro mate/matt black	1/10
991.823	497	negro mate/matt black	1/10
991.824	597	negro mate/matt black	1/10
991.825	697	negro mate/matt black	1/10
991.826	797	negro mate/matt black	1/10
991.827	897	negro mate/matt black	1/5
991.828	997	negro mate/matt black	1/5
991.829	1197	negro mate/matt black	1/5
991.830	3.000	negro mate/matt black	1/15



Jiefe

Código Code	L	Acabado Finish	
991.111	147	efecto inox/stainless steel look	1/15
991.112	197	efecto inox/stainless steel look	1/15
991.113	247	efecto inox/stainless steel look	1/15
991.114	297	efecto inox/stainless steel look	1/15
991.115	347	efecto inox/stainless steel look	1/15
991.116	397	efecto inox/stainless steel look	1/15
991.117	447	efecto inox/stainless steel look	1/10
991.118	497	efecto inox/stainless steel look	1/10
991.119	597	efecto inox/stainless steel look	1/10
991.120	697	efecto inox/stainless steel look	1/10
991.121	797	efecto inox/stainless steel look	1/10
991.122	897	efecto inox/stainless steel look	1/5
991.123	997	efecto inox/stainless steel look	1/5
991.124	1197	efecto inox/stainless steel look	1/5

Código Code	L	Acabado Finish	
991.617V	147	cava cepillado/brushed champagne brass	1/15
991.618	197	cava cepillado/brushed champagne brass	1/15
991.619V	247	cava cepillado/brushed champagne brass	1/15
991.620	297	cava cepillado/brushed champagne brass	1/15
991.621V	347	cava cepillado/brushed champagne brass	1/15
991.622	397	cava cepillado/brushed champagne brass	1/15
991.623	447	cava cepillado/brushed champagne brass	1/10
991.624	497	cava cepillado/brushed champagne brass	1/10
991.625	597	cava cepillado/brushed champagne brass	1/10
991.626	697	cava cepillado/brushed champagne brass	1/10
991.627V	797	cava cepillado/brushed champagne brass	1/10
991.628	897	cava cepillado/brushed champagne brass	1/5
991.629	997	cava cepillado/brushed champagne brass	1/5
991.630V	1197	cava cepillado/brushed champagne brass	1/5

JEY2

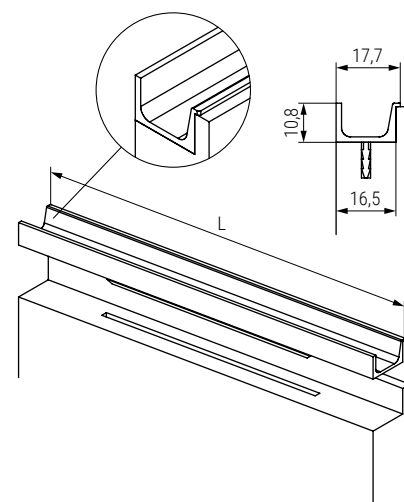

Código Code	L	Acabado Finish	
991.831	147	blanco mate/matt white	1/15
991.832	197	blanco mate/matt white	1/15
991.833	247	blanco mate/matt white	1/15
991.834	297	blanco mate/matt white	1/15
991.835	347	blanco mate/matt white	1/15
991.836	397	blanco mate/matt white	1/15
991.837	447	blanco mate/matt white	1/10
991.838	497	blanco mate/matt white	1/10
991.839	597	blanco mate/matt white	1/10
991.840	697	blanco mate/matt white	1/10
991.841	797	blanco mate/matt white	1/10
991.842	897	blanco mate/matt white	1/5
991.843	997	blanco mate/matt white	1/5
991.844	1197	blanco mate/matt white	1/5
991.845	3.000	blanco mate/matt white	1/15

Código Code	L	Acabado Finish	
991.846	147	negro mate/matt black	1/15
991.847	197	negro mate/matt black	1/15
991.848	247	negro mate/matt black	1/15
991.849	297	negro mate/matt black	1/15
991.850	347	negro mate/matt black	1/15
991.851	397	negro mate/matt black	1/15
991.852	447	negro mate/matt black	1/10
991.853	497	negro mate/matt black	1/10
991.854	597	negro mate/matt black	1/10
991.855	697	negro mate/matt black	1/10
991.856	797	negro mate/matt black	1/10
991.857	897	negro mate/matt black	1/5
991.858	997	negro mate/matt black	1/5
991.859	1197	negro mate/matt black	1/5
991.860V	3.000	negro mate/matt black	1/15



Jiefe

Código Code	L	Acabado Finish	
991.413	247	efecto inox/stainless steel look	1/15
991.414	297	efecto inox/stainless steel look	1/15
991.415	347	efecto inox/stainless steel look	1/15
991.416	397	efecto inox/stainless steel look	1/15
991.417	447	efecto inox/stainless steel look	1/10
991.418	497	efecto inox/stainless steel look	1/10
991.419	597	efecto inox/stainless steel look	1/10
991.420	697	efecto inox/stainless steel look	1/10
991.421	797	efecto inox/stainless steel look	1/10
991.422	897	efecto inox/stainless steel look	1/5
991.423	997	efecto inox/stainless steel look	1/5

Código Code	L	Acabado Finish	
991.631V	147	cava cepillado/brushed champagne brass	1/15
991.632V	197	cava cepillado/brushed champagne brass	1/15
991.633V	247	cava cepillado/brushed champagne brass	1/15
991.634V	297	cava cepillado/brushed champagne brass	1/15
991.635V	347	cava cepillado/brushed champagne brass	1/15
991.636V	397	cava cepillado/brushed champagne brass	1/15
991.637V	447	cava cepillado/brushed champagne brass	1/10
991.638V	497	cava cepillado/brushed champagne brass	1/10
991.639	597	cava cepillado/brushed champagne brass	1/10
991.640V	697	cava cepillado/brushed champagne brass	1/10
991.641V	797	cava cepillado/brushed champagne brass	1/10
991.642V	897	cava cepillado/brushed champagne brass	1/5
991.643V	997	cava cepillado/brushed champagne brass	1/5
991.644V	1197	cava cepillado/brushed champagne brass	1/5

VECTOR

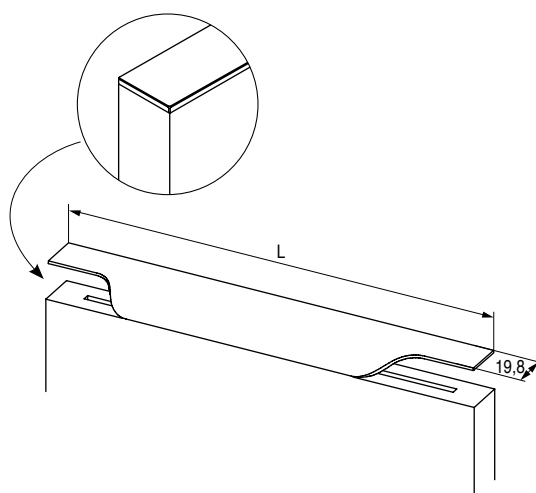
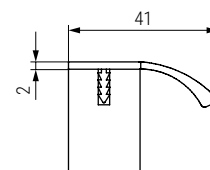

- Para espesor de 19mm.
- Disponible tambien para espesores de 20,5 mm. y 22mm.
- Bajo pedido. Consultar disponibilidad.
- For 19 mm thickness.
- Also available for 20.5 mm and 22 mm thicknesses.
- On request. Please check availability.

Código Code	L	Acabado Finish	
991.1157	147	negro cepillado/brushed black	15
991.1158	197	negro cepillado/brushed black	15
991.1159	247	negro cepillado/brushed black	15
991.1160	297	negro cepillado/brushed black	15
991.1161	347	negro cepillado/brushed black	15
991.1162	397	negro cepillado/brushed black	15
991.1163	447	negro cepillado/brushed black	10
991.1164	497	negro cepillado/brushed black	10
991.1165	597	negro cepillado/brushed black	10
991.1166	697	negro cepillado/brushed black	10
991.1167	797	negro cepillado/brushed black	10
991.1168	897	negro cepillado/brushed black	5
991.1169	997	negro cepillado/brushed black	5
991.1170	1197	negro cepillado/brushed black	5

LINEAR

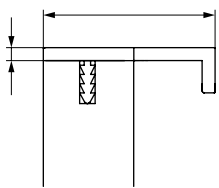

- Para espesor de 19mm.
- Disponible tambien para espesores de 20,5 mm.
- Bajo pedido. Consultar disponibilidad.
- For 19 mm thickness.
- Also available for 20.5 mm.
- On request. Please check availability.

Código Code	L	Acabado Finish	
991.541	147	negro cepillado/brushed black	1/15
991.542V	197	negro cepillado/brushed black	15/60
991.543V	247	negro cepillado/brushed black	15/60
991.544	297	negro cepillado/brushed black	1/15
991.545	347	negro cepillado/brushed black	1/15
991.546	397	negro cepillado/brushed black	1/15
991.547	447	negro cepillado/brushed black	1/10
991.548	497	negro cepillado/brushed black	1/10
991.549	597	negro cepillado/brushed black	1/10
991.550	697	negro cepillado/brushed black	1/10
991.551	797	negro cepillado/brushed black	1/10
991.552	897	negro cepillado/brushed black	1/5
991.553	997	negro cepillado/brushed black	1/5
991.554	1197	negro cepillado/brushed black	1/5

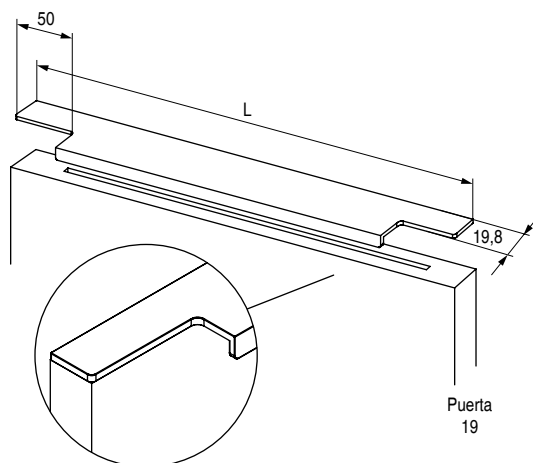

BALBI SP19

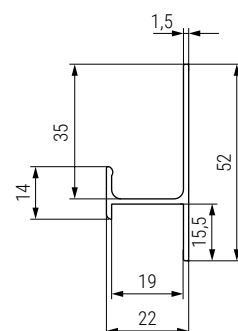
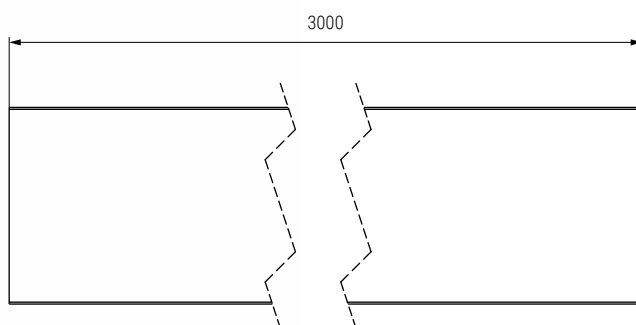
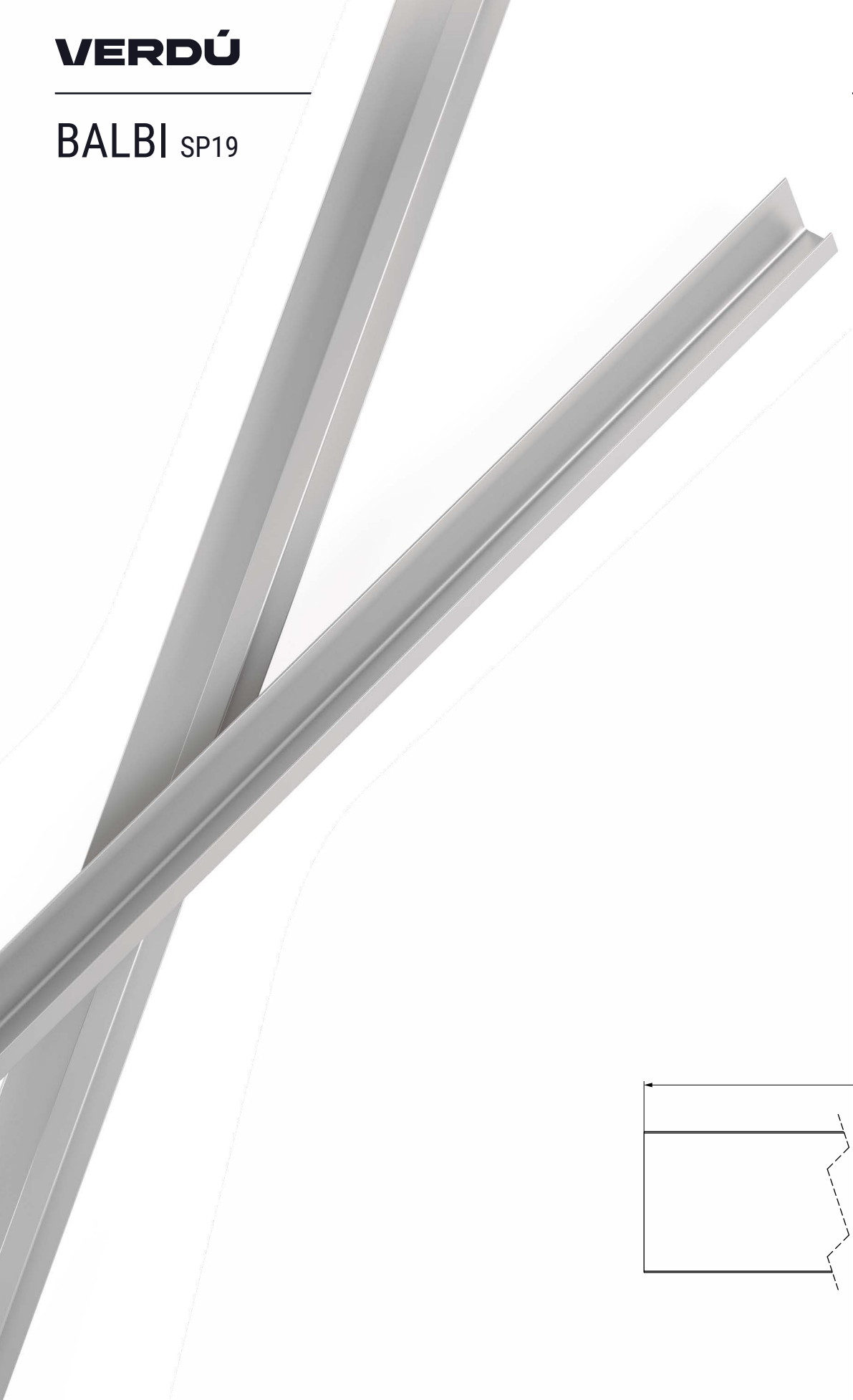

- Posibilidad de pedir también espesor de 16mm.
- Bajo pedido. Consultar disponibilidad.
- Also available in 16 mm thickness
- Available on request. Check availability.

Código Code	Largo Long	Acabado Finish	
773.111	3m.	plata mate/matt silver	1/30

BALBI SP16

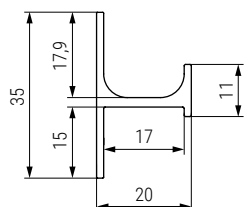
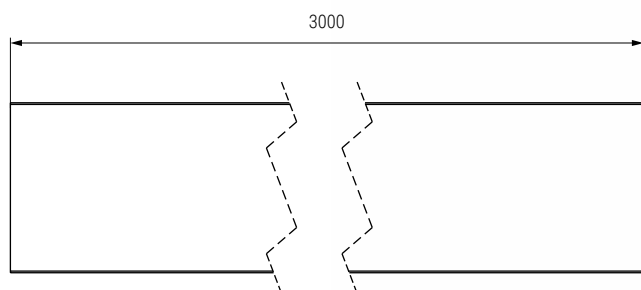
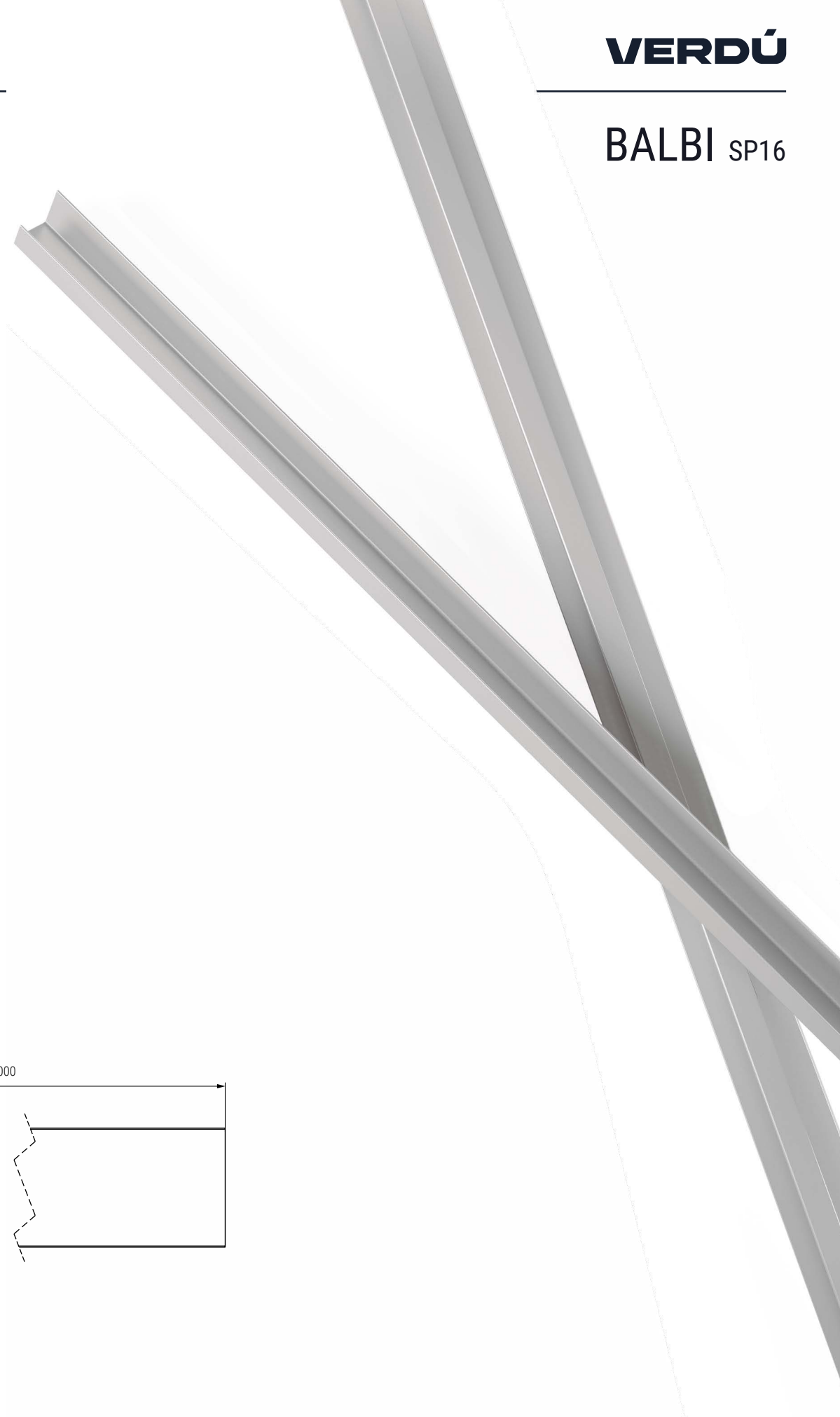

Código
Code

773.112

Largo
Long

3m.

Acabado
Finish

plata mate/matt silver



1/10

PERFILERÍA DE ARMARIO

SOLUCIONES DE APERTURA INTEGRADA





SIX

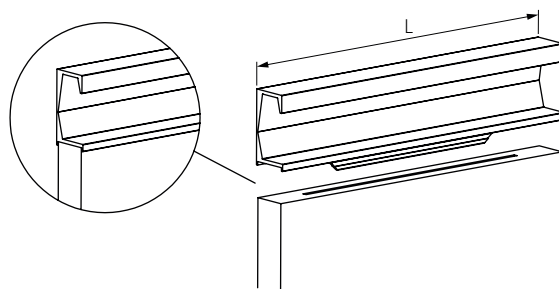

• Todos los acabados son texturizados.
 • All finishes are textured.

Código Code	L	Acabado Finish	
991.1099	597	blanco mate/matt white	1/10
991.1100	597	negro lava/lava black textured	1/10
991.1102	3000	blanco mate/matt white	1/5
991.1103	3000	negro lava/lava black textured	1/5

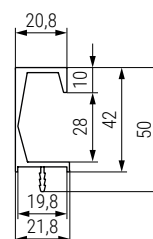





HEXXA

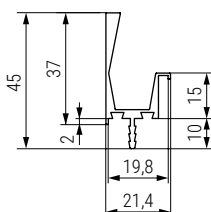

• Todos los acabados son texturizados.
• All finishes are textured.

Código Code	L	Acabado Finish	
991.461	200	blanco mate/matt white	1/25
991.462	200	negro cepillado/brushed black	1/25
991.465V	350	blanco mate/matt white	1/25
991.466V	350	negro cepillado/brushed black	1/25
991.469	1100	blanco mate/matt white	1/15
991.470	1100	negro cepillado/brushed black	1/15
991.473	3000	blanco mate/matt white	1/10
991.474	3000	negro cepillado/brushed black	1/10

SALIN

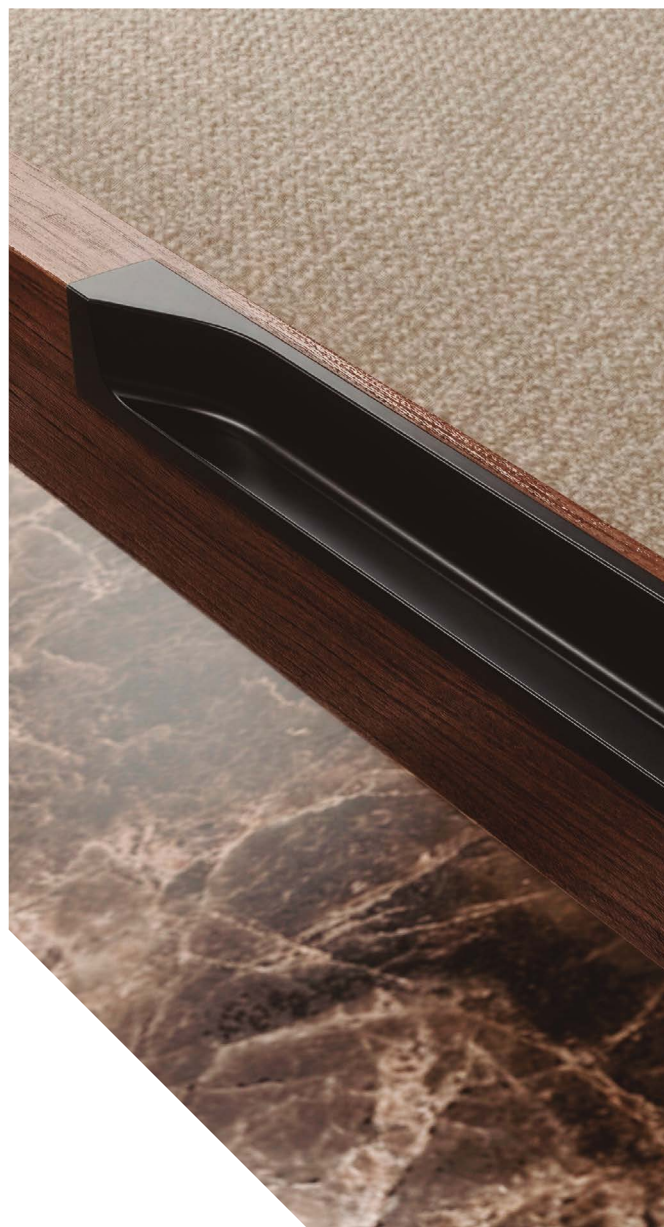

Código Code	C	L	Acabado Finish	
544.725	64	137	negro mate/matt black	1/25
544.727	64	137	blanco mate/matt white	1/25
544.726	128	201	negro mate/matt black	1/50
544.728	128	201	blanco mate/matt white	1/50

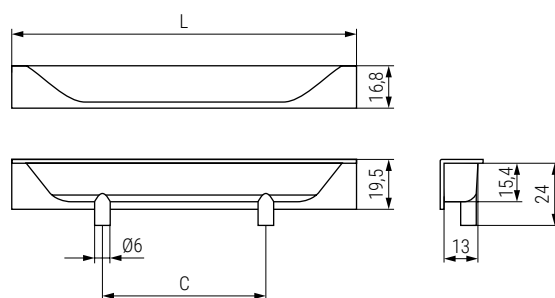

WAVE

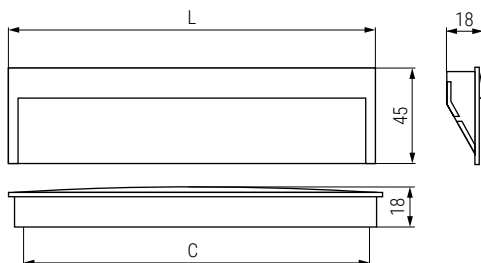

Código Code	C	L	Acabado Finish	
991.86	32	45	níquel cepillado/brushed nickel	1/25
991.84	32	45	negro mate/matt black	1/25
991.85	160	173	níquel cepillado/brushed nickel	1/25
991.83	160	173	negro mate/matt black	1/25

CASTO RECT

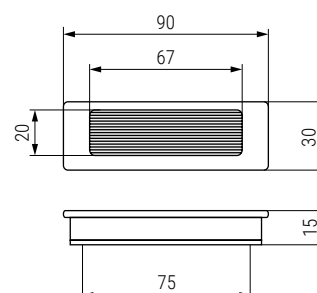

Código
Code

Acabado
Finish



544.103	antica firenze/antique brass	1/50
544.913	negro mate/matt black	1/50

CASTO OVAL

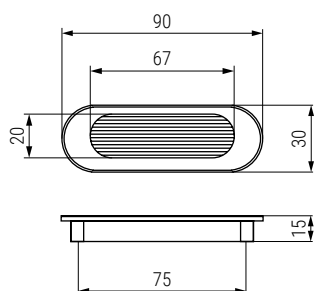

Código Code	Acabado Finish	
544.101	antica firenze/antique brass	1/50
544.911	negro mate/matt black	1/50

CUBIC



Código
Code

Acabado
Finish



991.339	negro mate/matt black	1/25
991.340	blanco mate/matt white	1/25

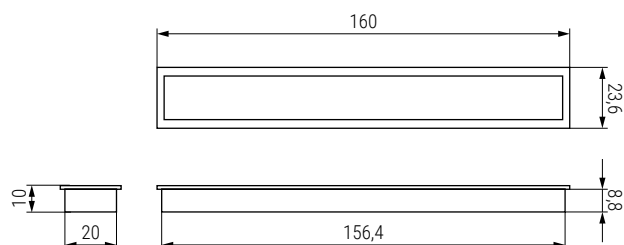

CLOS

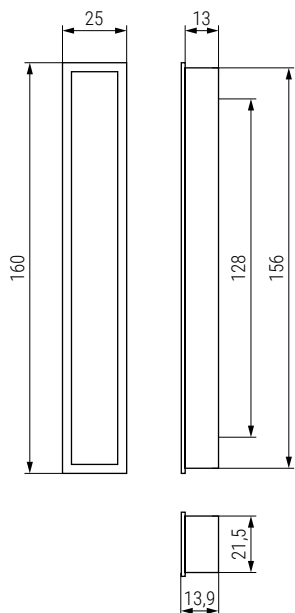

Código Code	Acabado Finish	
991.342	níquel cepillado/brushed nikckel	1/25
991.343	blanco mate/matt white	1/25
991.344	negro mate/matt black	1/25



SERIE DADO

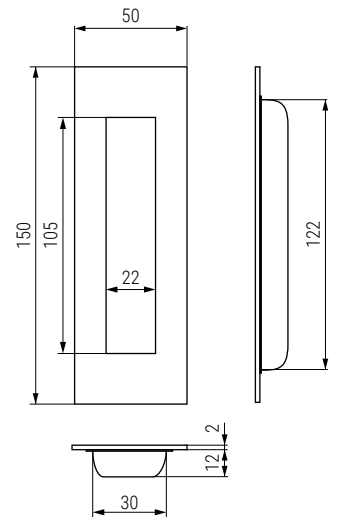
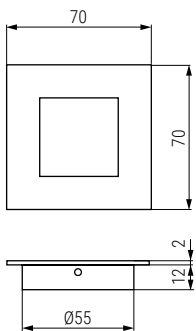
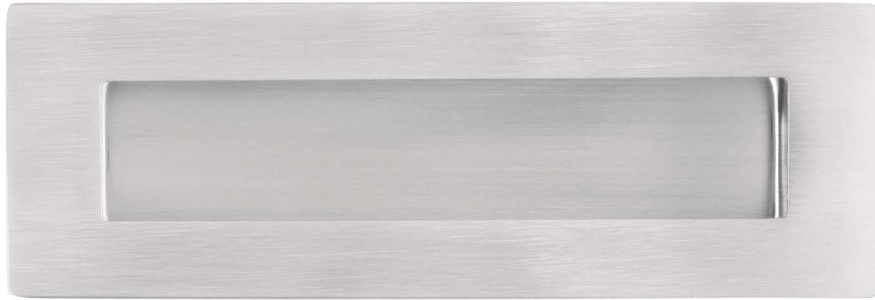

Código
Code

3522.117

Acabado
Finish

inox mate/matt stainless steel



1/10

Código
Code

3522.118

Acabado
Finish

inox mate/matt stainless steel



1/10

SERIE TONDOR

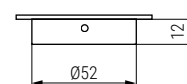
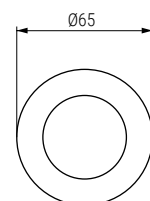
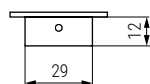
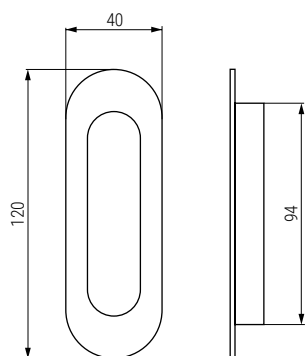
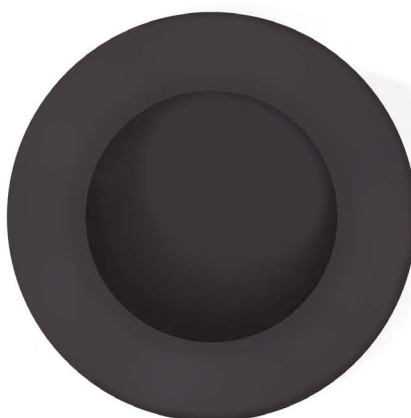
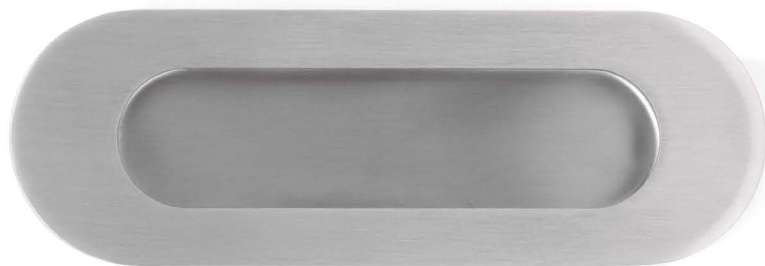

Código
Code

Acabado
Finish



3522.18
3522.98

inox mate/matt stainless steel
negro mate/matt black

1/10
1/10

Código
Code

Acabado
Finish



3522.17
3522.97

inox mate/matt stainless steel
negro mate/matt black

1/20
1/10



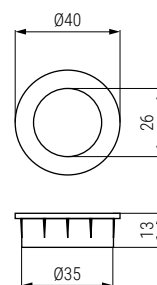

KONA

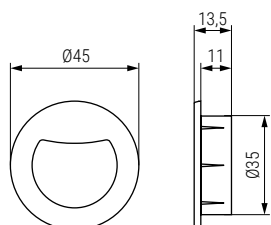

Código Code	Acabado Finish	
1435.491	negro/black	1/100
1435.492	aluminio RAL9006/aluminium RAL9006	1/100
1435.490	blanco mate/matt white	1/100

MARIET



Código Code	Acabado Finish	
9035.507	aluminio RAL9006/aluminium RAL9006	1/75
9035.508	negro mate/matt black	1/75
9035.509	blanco mate/matt white	1/75

PULGA



Código Code	Material	Acabado Finish	
195.13	plástico/plastic	blanco/white	5.000

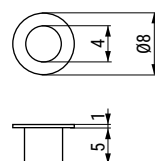

DIN 125



Código Code	ØA	ØB	Material	Acabado Finish	
1349.5	4	9	nilón/nylon	blanco/white	1.000
1349.7	5	10	nilón/nylon	blanco/white	1.000
1349.6	6	12	nilón/nylon	blanco/white	1.000
1349.8	8	16	nilón/nylon	blanco/white	1.000
1349.4	10	30	nilón/nylon	blanco/white	1.000
1349.10	12	40	nilón/nylon	blanco/white	1.000

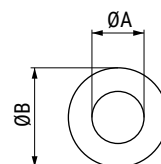

NICO M4

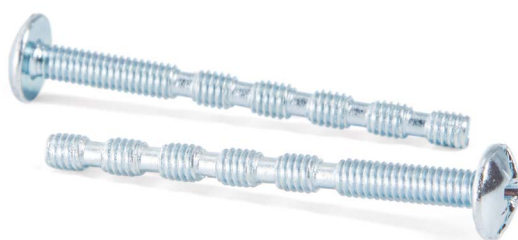

Código Code	Material	Acabado Finish	
1032.1	acero/steel	zincado/zinc-plated	500

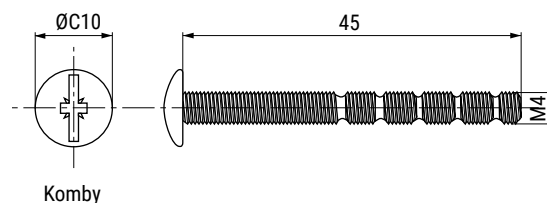

COMBO M4



M	L Longitud Length mm.		Negro zincado Zinc-plated black	Níquel Nickel
			Código Code	Código Code
M4 ØC10	8	1.000		679.40
	10	1.000		679.39
	12	1.000		1170.40
	15	1.000		1170.43
	18	1.000		1170.44
	20	1.000	1170.61	1170.31
	22,5	1.000	1170.62	1170.24
	25	1.000	1170.63	1170.25
	27,5	1.000		1170.26
	30	1.000	1170.64	1170.27
	32	1.000	1170.66	1170.36
	35	1.000	1170.65	1170.28
	37	1.000		1170.39
	40	1.000		1170.29
50	500		1170.41	
60	500		1170.42	

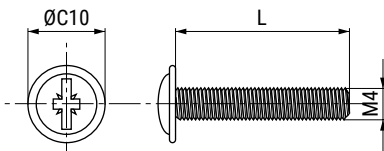

Komby

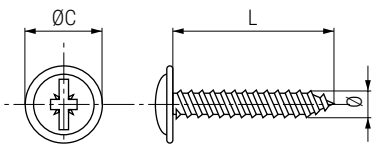

Komby

- Ideal para pomos de madera.
- Ideal for wooden knobs.
- Ideal para traseras de armario.
- Ideal for wardrobe back panels.
- Material: Hierro.
- Material: Iron.

EGO R/MADERA

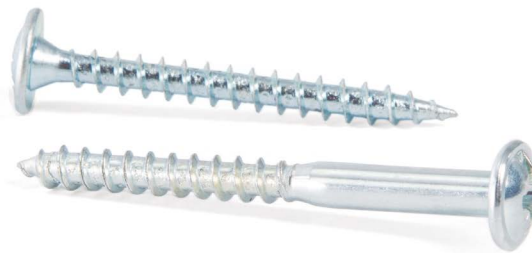

Ø	L Longitud Length mm.		Galvanizado Galvanized	Zincado Zinc-plated
			Código Code	Código Code
3 ØC 7,8	20	15.000	9011.201	9011.134

Ø	L Longitud Length mm.		Zincado Zinc-plated	
			Código Code	Código Code
3,5 ØC 8,6	20	3.000	1393.8	
	30	3.000	1393.9	

Ø	L Longitud Length mm.		Negro zincado Zinc-plated black	Zincado Zinc-plated
			Código Code	Código Code
4 ØC 10	20	8.000	1393.41	1393.21
	25	7.500		1393.16
	30	6.500		1393.17
	35	5.500		1393.18
	40	5.000		1393.19