



PERFILERÍA DE ARMARIO

SOLUCIONES DE APERTURA INTEGRADA

Perfil vertical tirador CALAS SP19



CALAS 30 BAJO

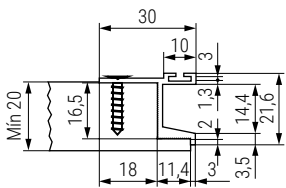

Código	Largo	Material	Acabado	
398.55	2,60m.	aluminio	Anodizado plata mate	10

CALAS 44 MEDIO

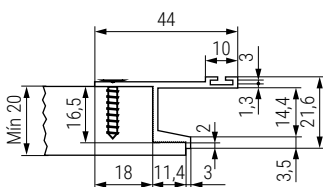

Código	Largo	Material	Acabado	
398.53	2,60m.	aluminio	Anodizado plata mate	10

CALAS 50 ALTO

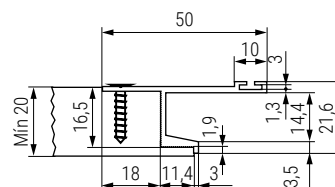

Código	Largo	Material	Acabado	
398.51	2,60m.	aluminio	Anodizado plata mate	10



Perfil vertical tirador ATENEO SP19



ACTUALIZADO EL DÍA 04/12/2025

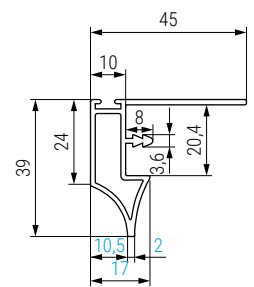
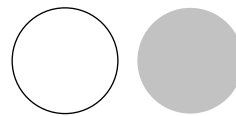

Código		Largo	Material	
Anodizado plata mate	Blanco mate R9016	2,75m.	aluminio	10
398.31	398.72			

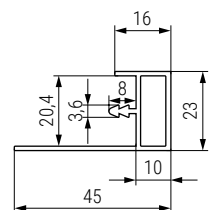
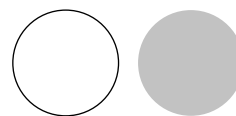

Código		Largo	Material	
Anodizado plata mate	Blanco mate R9016	2,75m.	aluminio	10
398.32	398.74			

Perfil vertical tirador LIA SP19

Perfil vertical tirador DUCADO SP19

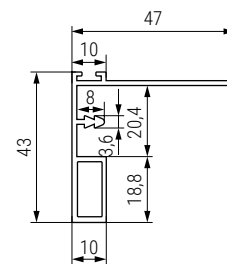
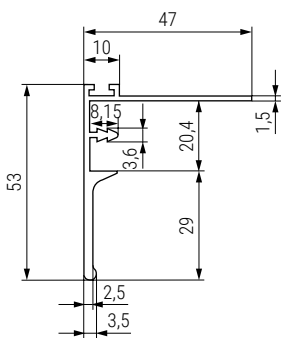
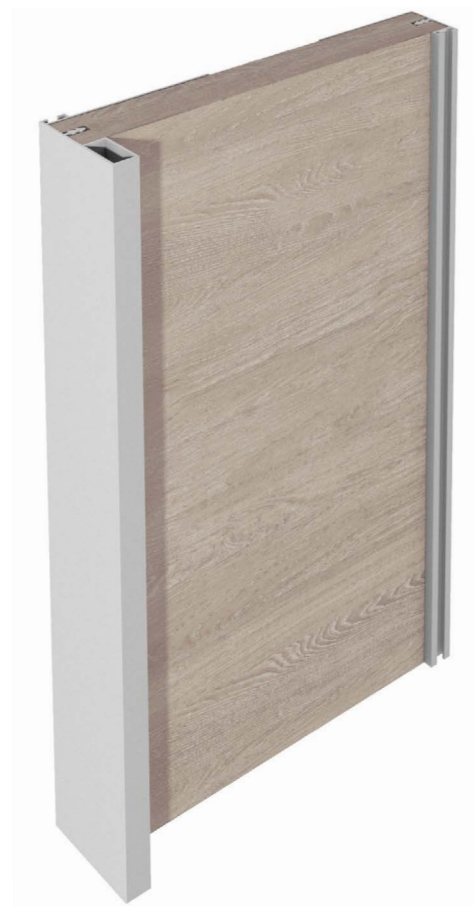

19-20mm.

Código	Largo	Material	Acabado	
398.30	2,60m.	aluminio	anodizado plata mate	10

ACTUALIZADO EL DÍA 22/09/2025



19-20mm.

Código	Largo	Material	Acabado	
398.34	2,75m.	aluminio	anodizado plata mate	10
398.91	2,75m.	aluminio	blanco mate R9016	10
398.92	2,75m.	aluminio	negro mate	10

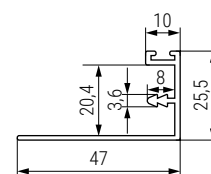
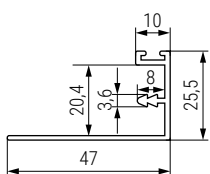

19-20mm.

Código	Largo	Material	Acabado	
398.33	2,75m.	aluminio	anodizado plata mate	10



19-20mm.

Código	Largo	Material	Acabado	
398.33	2,75m.	aluminio	anodizado plata mate	10
398.93	2,75m.	aluminio	blanco mate R9016	10
398.94	2,75m.	aluminio	negro mate	10

Perfil vertical tirador CAPRI SP19



Perfil vertical tirador BALBI SP16/19



Código			Largo	Material	
Plata mate	Blanco mate	Negro mate	2,7m.	aluminio	10
1346.111	1346.114	1346.112			

Código	Largo	Material	Acabado	
773.112	3m.	aluminio	anodizado plata mate	10

ACTUALIZADO EL DÍA 21/01/2026

Código			Largo	Material	
Plata mate	Blanco mate	Negro mate	2,75m.	aluminio	10
398.32	398.74	398.75			

ACTUALIZADO EL DÍA 23/12/2025

Código	Largo	Material	Acabado	
773.111	3m.	aluminio	anodizado plata mate	10

Perfil para cantos de aluminio VIATORE SP19
Embutir



Perfil para cantos de aluminio HANOI SP19
Embutir

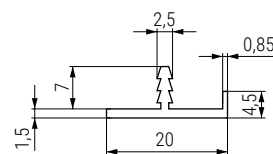
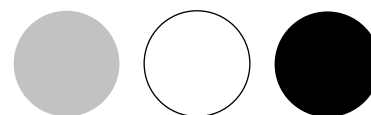
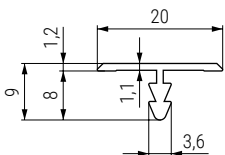

ACTUALIZADO EL DÍA 21/01/2026



Código	Largo	Material	Acabado	
398.36	3,20m.	aluminio	anodizado plata mate	10

Código			Largo	Material	
Plata mate	Blanco mate	Negro mate	3,2m.	aluminio	10
398.2	398.81	398.85			

Perfil para cantos de puertas, en aluminio **ETON**

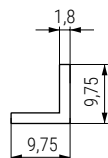
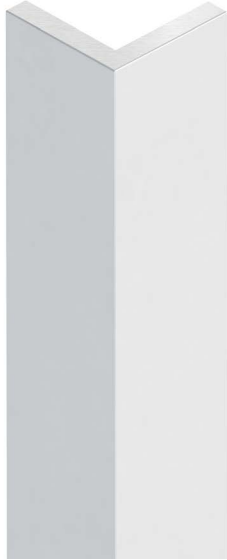

Código	Largo	Material	Acabado	
398.4	3m.	aluminio	anodizado plata mate	10

Perfil japonesa de aluminio **JAPAN SP19**
Embutir

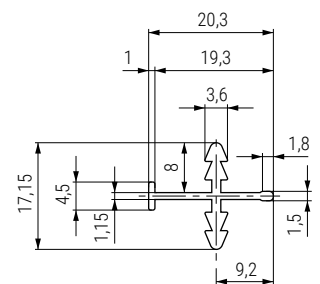

Código	Largo	Material	Acabado	
398.37	3,2m.	aluminio	anodizado plata mate	10

BURLETE 7x10 Cepillo salvapolvo adhesivo

Burlete
by ALK®

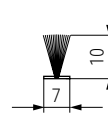
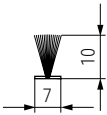

CÓDIGO

Gris	Negro	Material	
1304.27	1304.28	PVC-fibra	10m.

CÓDIGO

Gris	Negro	Material	
1304.17	1304.18	PVC-fibra	200m.





**BUSCA SOLUCIONES QUE SE
INTEGREN EN TU COCINA**

GOLA J2 Perfil gola para colocación en muebles bajos

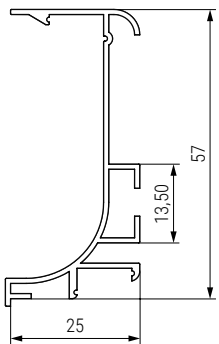

• Para cubrir la tira de LED usaremos el perfil tapa de policarbonato. Pedir por separado.

CÓDIGO	Largo	Acabado	
1274.150	4m.	antracita	10 barras
1274.151	4m.	plata mate	10 barras
1274.152	4m.	lacado blanco	10 barras
1274.153	4m.	lacado negro	10 barras

Accesorios Perfil GOLA J2 Tapa lateral Mueble Bajo



Código	Acabado	Material	
1274.156	plata mate	zamak	6
1274.161	blanco	zamak	6
1274.166	negro	zamak	6
1274.171	antracita	zamak	6

Accesorios Perfil GOLA J2 Rincon y Esquina Mueble Bajo

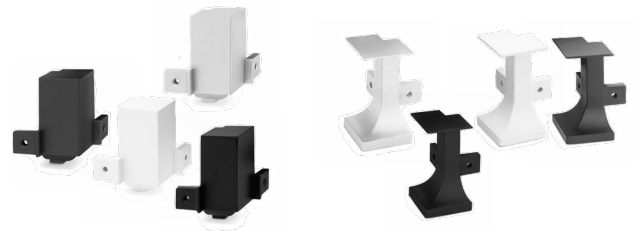

Código		Acabado	Material	
Rincón	Esquina			
1274.157	1274.158	plata mate	zamak	6
1274.162	1274.163	blanco	zamak	6
1274.167	1274.168	negro	zamak	6
1274.172	1274.173	antracita	zamak	6

Accesorios Perfil GOLA J2 Tapa policarbonato Mueble Bajo



Código	Largo	Acabado	
1274.154	2m.	translúcido	3

Escuadra para fijar perfil GOLA J2
Con tornillo de fijación al perfil incluido



Código	Material	Acabado	
1274.135	acero	plata mate	25

GOLA A Perfil gola horizontal para colocación en muebles altos
Para módulos de cocina



Perfil diseñado para introducir sistema de iluminación LED, (opcional).

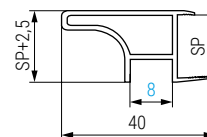
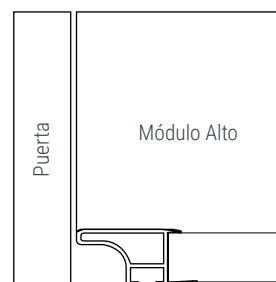

- Cubierta de policarbonato incluida con el perfil.
- Si se desea poner iluminación, ver rollos de led.

ACTUALIZADO EL DÍA 08/05/2026

Código		Largo	Acabado	Material	
SP 16mm.	SP 19mm.				
1274.107	1274.207	4m.	lacado negro	aluminio	20 barras
1274.108	1274.208	4m.	antracita	aluminio	20 barras
1274.109	1274.209	4m.	lacado blanco	aluminio	20 barras
1274.110	1274.210	4m.	plata mate	aluminio	20 barras

GOLA S Perfil gola simple vertical
Para módulos de cocina

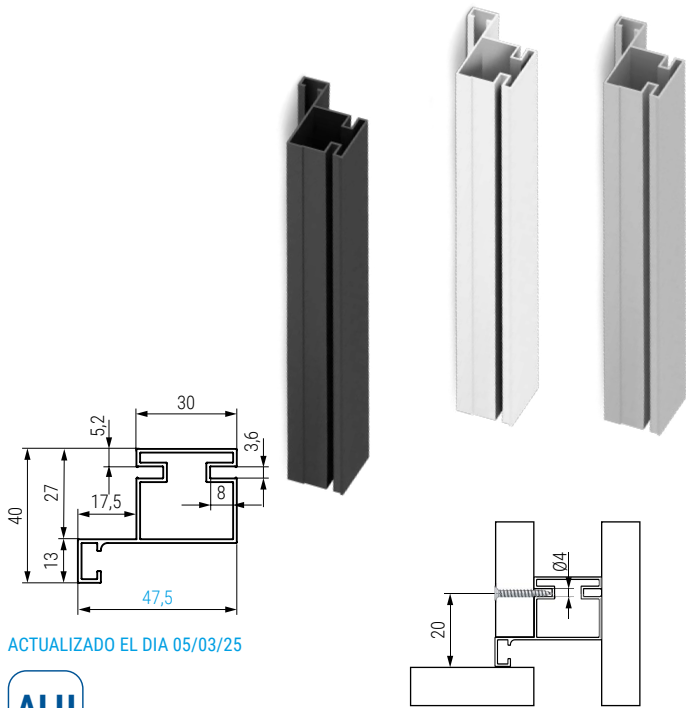

ACTUALIZADO EL DIA 05/03/25



• Tapa de policarbonato incluida.

CÓDIGO	Largo	Material	Acabado	
1274.256	2,5m.	aluminio	lacado negro	6 barras
1274.257	2,5m.	aluminio	lacado blanco	6 barras
1274.258	2,5m.	aluminio	plata mate	6 barras

GOLA D Perfil gola doble vertical
Para módulos de cocina

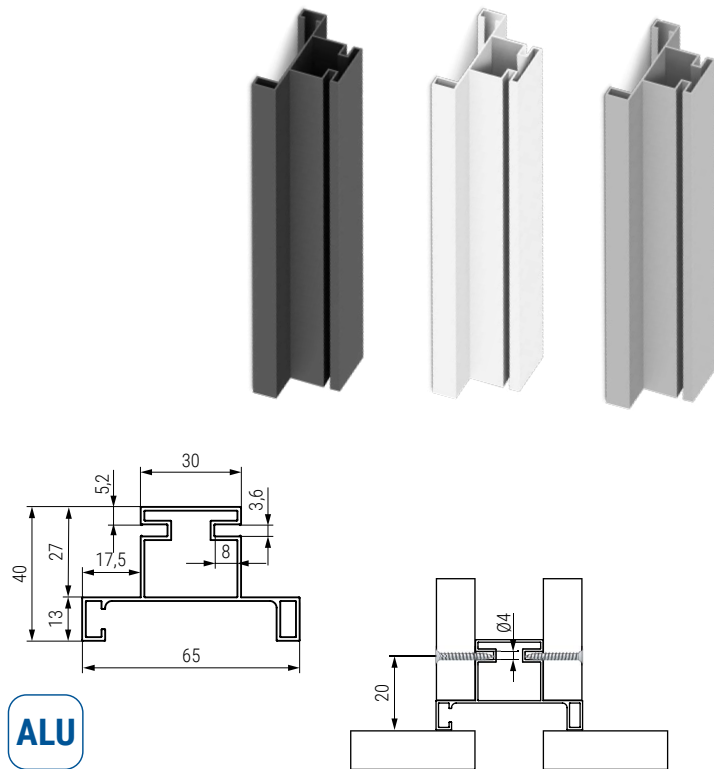

• Tapa de policarbonato incluida.

CÓDIGO	Largo	Material	Acabado	
1274.251	2,5m.	aluminio	lacado negro	6 barras
1274.252	2,5m.	aluminio	lacado blanco	6 barras
1274.253	2,5m.	aluminio	plata mate	6 barras



VISITA NUESTRO
CATALOGO DE TIRADORES



Catálogo de tiradores